

MAC Viper™ Profile

USER GUIDE



Martin®

User Documentation update information

Any important changes in the MAC Viper Profile User Guide are listed below.

Revision D

Covers firmware version 1.1.0. Control of breakup and aerial wheels in fixtures running firmware 1.1.0 now matches the User Guide.

Revision C

First version released. Covers firmware version 1.0.0 but in fixtures running this version, the order in which the breakup and aerial wheels is controlled via DMX and in the control menu is reversed compared to the User Guide.

© 2012 Martin Professional A/S. Information subject to change without notice. Martin Professional A/S and all affiliated companies disclaim liability for any injury, damage, direct or indirect loss, consequential or economic loss or any other loss occasioned by the use of, inability to use or reliance on the information contained in this document. The Martin logo, the Martin name and all other trademarks in this document pertaining to services or products by Martin Professional A/S or its affiliates and subsidiaries are trademarks owned or licensed by Martin Professional A/S or its affiliates or subsidiaries.

P/N 35000259, Rev. D

Contents

Introduction	4
Effects	5
Shutter and strobe effects	5
Dimming	5
Cyan, Magenta, Yellow and CTO	5
Color wheel	5
Breakup and aerial effects	5
FX wheel (animation and gobo effects)	5
Beam effect (rotating prism)	7
Iris	7
Frost	7
Focus and zoom	7
Pan and tilt	7
Optical configuration	8
Prism	8
Color wheel	8
FX wheel	9
Breakup and aerial gobos	10
Control panel operations	11
DMX address	12
DMX modes	12
Fixture ID	13
Personality	13
Factory defaults	14
Fixture information readouts	14
DMX signal monitoring	15
Test sequences	15
Manual control	15
Adjusting settings via DMX	16
Resetting	16
Lamp on / off	16
Illuminating the display	16
Control menu setting overrides	16
RDM	17
RDM ID	17
RDM communication	17
Software service functions	18
Service utilities	18
Calibration	18
Firmware installation	19
DMX protocol	20
Control panel menus	28
Service and display messages	33

Introduction

This User Guide is a supplement to the Installation and Safety Manual that is supplied with the MAC Viper Profile. Both documents are available for download from the Martin™ website at www.martin.com. The User Guide contains information that is mainly of interest for lighting designers and operators, whereas the Safety and Installation Manual contains important information for all users, especially installers and technicians.

Before using the MAC Viper Profile, check the latest version of the Installation and Safety Manual, paying particular attention to the Safety Precautions section.

We recommend that you check the Martin™ website regularly for updated documentation. A revised version of this User Guide will become available each time we can improve the quality of the information in the guide and each time a new firmware version is released that contains changes or new features. Each time this guide is revised, any important changes will be listed on page 2 so that you can keep track of updates.

This is revision D of the MAC Viper Profile User Guide. An updated version of this guide with more detailed information on calibration procedures, RDM and error messages in the fixture's display is due to be released on the Martin website late 2012. Until then, the MAC Viper Profile is capable of returning information about the RDM commands it supports to an RDM controller, and the full-text error messages in the display give a good indication of the type of error, if the fixture detects one.

Effects

This section gives details of the effects that can be controlled via DMX. See the DMX protocol table on page 20 for details of the channels used to control them.

Where fine control is available, the main control channel sets the first 8 bits (the most significant byte or MSB), and the fine channels set the second 8 bits (the least significant byte or LSB) of the 16-bit control byte. In other words, the fine channel works within the position set by the coarse channel.

Shutter and strobe effects

The MAC Viper Profile's dimmer/shutter provides instant blackout and snap open as well as regular or random strobe and pulse effects with variable speed from approx. 2 Hz to 10 Hz.

Dimming

The dimmer/shutter provides smooth, high-resolution 100 percent fading.

Fine dimming control is available in extended 16-bit mode.

Cyan, Magenta, Yellow and CTO

The amount of cyan, magenta, yellow and CTO (Color Temperature Control Orange) applied to the MAC Viper Profile's light output can be varied from zero to 100%.

The CTO flags installed as standard allow color temperature to be made warmer from 0 to +145 mireds, giving a reduction in color temperature from 6000 K at zero CTO to 3200 K at full CTO.

Color wheel

The color wheel has eight color filters that can be applied as split colors or in full-color steps. The color wheel can also be scrolled continuously, applying the color filters in sequence with control of color wheel speed and direction. Color filters can also be applied at random at fast, medium or slow speed.

Breakup and aerial effects

The breakup and aerial wheels each have five rotating gobos that can be selected, indexed (positioned at an angle), rotated continuously, and shaken (bounced). The wheels can also be scrolled continuously or shaken. Gobo indexing, continuous gobo rotation, gobo shake and continuous wheel scrolling are selected on one channel for each wheel. Depending on what is selected on this first channel for each wheel, the gobo indexed angle or gobo rotation speed are set on the next channel. If gobo indexing is selected on the first channel, fine control of gobo indexed angle is available on the third control channel for each wheel in both basic 16-bit and extended 16-bit modes.

FX wheel (animation and gobo effects)

The FX wheel has a gobo animation range and four integral gobos. You can create animated effects by combining FX wheel movement with gobos on the breakup and/or aerial wheels. A huge number of possible combinations of beam pattern and movement types is available.

When using gobo animation, adjust the fixture's focus to obtain the most realistic results.

FX wheel control

The FX wheel uses two DMX channels:

- On the first channel, you set the FX wheel position or select a movement option.
- On the second channel, you adjust movement speed if you have selected one of the movement options.

Limiting movement range

You can set limits for the range of FX wheel movement in the control menu **PERSONALITY** → **GOBO 3 FX RANGE**. This feature allows you to limit movement to the animation range, for example, if you will not be using the gobos on the FX wheel.

FX wheel movement options

The following types of movement are available on the FX wheel position/movement channel.

Smooth

Continuous speed across the whole range with deceleration/acceleration at end points.

Organic

Continuous speed across the whole range with deceleration/acceleration at end points.

Each fixture uses a random position and direction. In an array of fixtures, changes in direction are not visible because they are hidden in the overall animation pattern.

Metronome

The FX wheel is positioned at the center of its range. The wheel bounces back and forth at identical angles.

There is some acceleration when leaving the end point.

The speed channel increases/decreases angle and speed at the same time.

Play forwards / fast rewind

The FX wheel moves forwards through its range at the speed set on the speed channel, stops, then moves backwards through its range at a fixed speed (this is slightly slower than maximum speed, so the wheel scrolls back through the range).

Play backwards / fast rewind

The FX wheel moves backwards through its range at the speed set on the speed channel, stops, then moves forwards through its range at fixed speed (this is slightly slower than maximum speed, so the wheel scrolls back through the range)

Random bounce

The FX wheel is positioned at the center of its range. The wheel bounces at set speed to random position from center, bounces alternate left and right of center.

Interference

The FX wheel is positioned at the center of its range. The wheel bounces with set time to random position from center, bounces alternate left and right of center.

Adjusting speed increases time and distance of left/right positions.

Random animation position

Moves the FX wheel to random positions within the animation range. Time to next position is determined by speed setting.

Random gobo position

Moves the FX wheel to random positions within the gobo range. Time to next position is determined by speed setting.

Random effects wheel position

Moves the FX wheel to random positions within the animation and gobo ranges. Time to next position is determined by speed setting.

Beam effect (rotating prism)

The four-facet prism can be applied at indexed angles or rotated with variable direction and speed.

Iris

The iris can be set to a static diameter, or regular and random pulsing effects can be set with variable speed.

Frost

The extent to which the frost filter is added to the beam is variable 0 - 100%.

Focus and zoom

The focus system allows sharp or soft projections. Focus range varies with zoom angle. At the narrowest zoom angle, nearest focus is approximately 6 meters (20 feet). As the zoom angle is widened, the nearest focus distance is reduced, down to approximately 2 meters (6.8 ft.), and far focus can be set to approximately infinity.

The separate zoom lens varies the focused beam angle from 10° to 44° with the standard lens installed.

Zoom/focus linking

Focus can be linked to zoom so that it automatically adjusts to match changes in zoom angle. Focus on rotating gobos matches zoom closely, while focus on the gobo animation wheel matches zoom best in the center of the zoom range and slightly less precisely at the two extremes of the zoom range.

Linked zoom/focus works within 3 distance ranges (figures are approximate):

- Near (5 - 10 meters)
- Medium (10 - 20 meters)
- Far (20 meters - infinity)

To link zoom and focus, select a distance range using the Fixture Control/Settings DMX channel or **FOCUS TRACKING** in the control panel **PERSONALITY** menu. Then adjust focus to obtain the required degree of sharpness. Linking is now enabled and focus will auto-adjust.

Pan and tilt

Coarse and fine pan and tilt control are available in both basic 16-bit and extended 16-bit modes.

Optical configuration

Prism

The MAC Viper Profile is supplied with an interchangeable four-facet 15° rotating prism (P/N 41300070) installed.

Color wheel

The MAC Viper Profile color wheel has 8 interchangeable dichroic filters and an open position (illustration shows color wheel viewed from front glass):

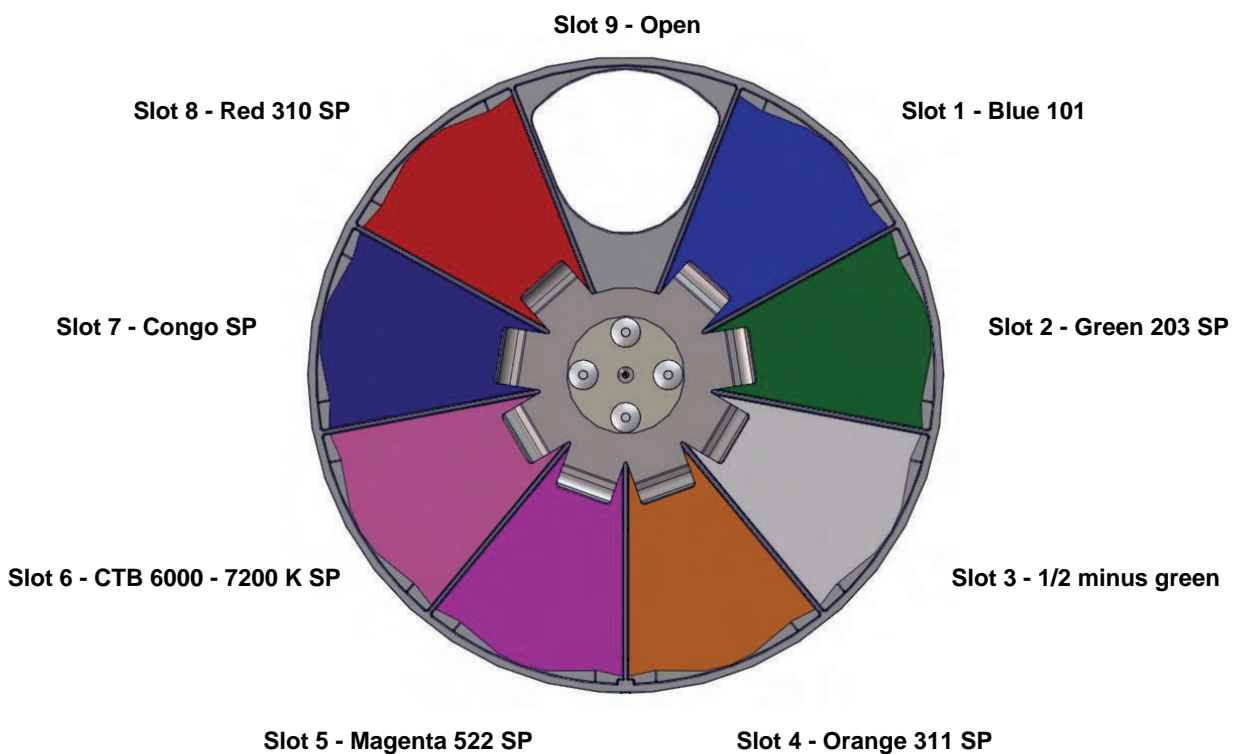

Figure 1: Color wheel

As standard, the MAC Viper Profile is supplied with the following color filters installed:

- Slot 1 - Blue 101 - P/N 46404700
- Slot 2 - Green 203 SP - P/N 46404710
- Slot 3 - 1/2 Minus green SP - P/N 46404780
- Slot 4 - Orange 311 SP - P/N 46404720
- Slot 5 - Magenta 522 SP - P/N 46404790
- Slot 6 - CTB 6000-7200K SP - P/N 46404770
- Slot 7 - Congo SP - P/N 46404750
- Slot 8 - Red 310 SP - P/N 46404760
- Slot 9 - Open

FX wheel

The MAC Viper Profile is supplied with the “Super Sic 58” FX wheel (P/N 43950059) installed. This wheel has an animation range that provides animation effects when used in conjunction with breakup gobos, for example, plus four integrated static gobos, plus an open position.

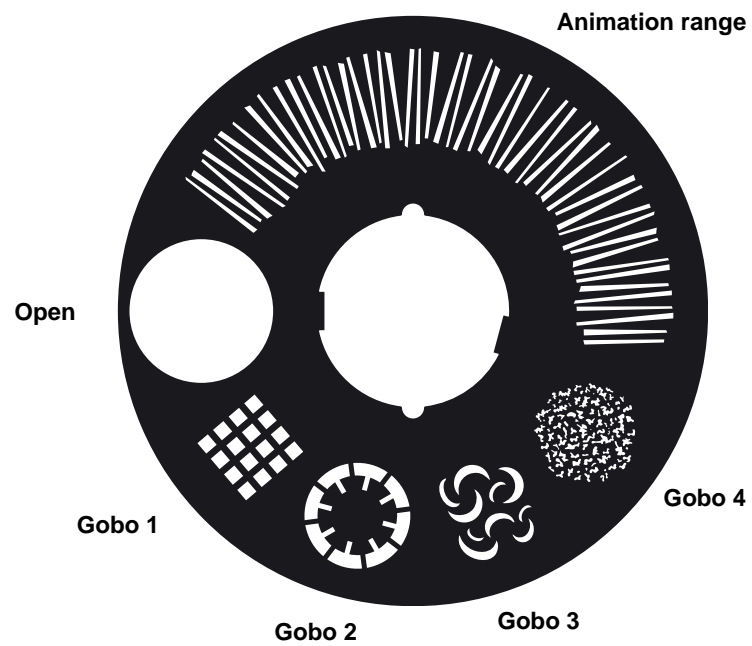

Figure 2: Super Sic 58 FX wheel

Breakup and aerial gobos

The breakup and aerial wheels in the MAC Viper Profile each provide 5 rotating gobos plus an open position. The standard gobos that are supplied installed in the fixture are shown in the correct order in Figure 3.

All gobos are interchangeable, but replacement gobos must match the dimensions, construction and quality of the gobos supplied as standard. The gobos are E-27 size (standard E-size 37.5 mm external diameter, 27 mm image area diameter). Limbo/Crystal is a custom gobo glued permanently into its holder. If you replace Limbo/Crystal, you will therefore need to order an additional goboholder.

Handling, installing and storing the gobos requires special care. See the MAC Viper Profile Safety and Installation Guide for details.

Breakup wheel

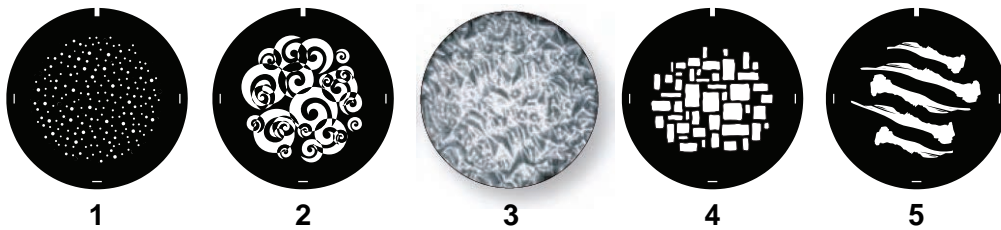

Aerial wheel

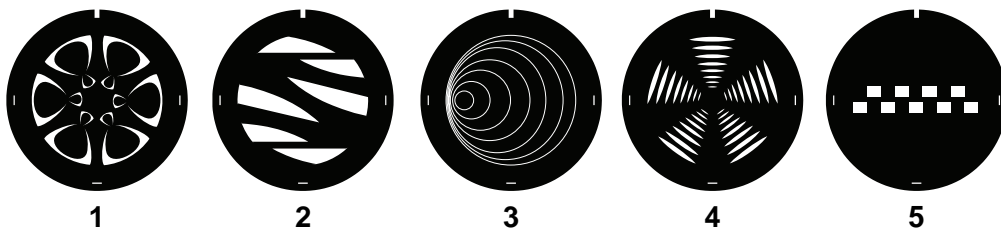

Breakup wheel (wheel 1)

1. Dots in space P/N 43092005
2. Happy P/N 43092006
3. Limbo/Crystal (in holder).. P/N 62325150
4. Brick it P/N 43062008
5. Big bones P/N 43062009

Aerial wheel (wheel 2)

1. Bite it P/N 43092011
2. Too many doctors P/N 43092001
3. Sonar P/N 43092002
4. Symmetrical leggings P/N 43092010
5. Zip it P/N 43092017

Figure 3: Breakup and aerial gobos

Control panel operations

You can configure individual fixture settings (such as the MAC Viper Profile's DMX address), read out data, execute service operations and view error messages using the fixture's backlit graphic display and control panel.



Figure 4: Display and control panel

When the MAC Viper Profile is powered on, it first boots and resets, then it displays its DMX address (or its fixture ID number, if one has been set) and any status messages (see page 33) in the display **A**.

The display can be set to automatically rotate to match standing or hanging fixture orientation in the **PERSONALITY** → **DISPLAY** menu or the Shortcuts menu (see “Shortcuts” on page 12).

Using the control panel

- Click (i.e. press in towards the fixture base once) the jog wheel **B** to access the menus.
- Rotate the jog wheel to scroll up and down menus.
- Click the jog wheel to enter a menu or make a selection.
- The currently selected item in a menu is indicated by a star ✱.
- Press the Escape button **C** to step backwards through the menus.

Status LED

An LED **D** next to the jog wheel indicates fixture status depending on the color displayed and DMX status depending on whether the LED flashes or lights constantly:

- **GREEN**: All parameters normal.
- **AMBER**: Warning (service interval exceeded, for example).
If **ERROR MODE** is set to **Normal**, the warning message will be shown in the display. If **ERROR MODE** is set to **Silent**, the display must be activated with the jog wheel to display the warning message.
- **RED**: Error detected.
If **ERROR MODE** is set to **Normal**, the error message will be shown in the display. If **ERROR MODE** is set to **Silent**, the display must be activated with the jog wheel to display the error message.
- **FLASHING**: No DMX signal detected.
- **CONSTANT**: Valid DMX signal detected.

If an error has been detected and the LED is red when the fixture is powered off, the LED will continue to flash red slowly. This feature allows easy identification of fixtures that require service intervention even if fixtures are disconnected from power.

Battery power

The display and control panel are powered by the MAC Viper Profile's onboard battery. This gives access to the most important functions in the control panel – including DMX addressing – when the fixture is not connected to AC power.

To activate the display when the fixture is not connected to power, press the Escape button. The display extinguishes after 10 seconds with no jog wheel activity and the control panel is de-activated after 1 minute with no jog wheel activity. Press the Escape button again to re-activate. The status LED flashes fixture status slowly when the fixture is not connected to power. The LED draws a minute current that can be sustained for several months without flattening the battery.

Shortcuts

If you hold the Escape button pressed in for 2 - 3 seconds, a shortcut menu with the most important commands appears. Select a command with the jog wheel and click the jog wheel to activate, or press Escape to cancel.

- **RESET ALL** resets the whole fixture
- **LAMP ON/OFF** strikes or douses the lamp.
- **ROTATE DISPLAY** rotates the MAC Viper Profile display 180°.

Settings stored permanently

The following settings are stored permanently in the fixture memory and are not affected by powering the MAC Viper Profile off and on or by updating the fixture software:

- DMX address
- DMX Protocol setting
- Fixture ID
- All personality settings (pan/tilt and pan/tilt limit, linked zoom/focus, lamp cooling, fan clean mode, dimming curve, DMX lamp off, DMX reset, parameter shortcuts, all display settings, error mode)
- Factory settings
- Fixture info (resettable power-on, lamp-on and lamp strike counters)
- All Service settings (adjust, calibration, firmware)

These settings can be returned to factory defaults using the control menus or via DMX.

DMX address

The DMX address, also known as the start channel, is the first channel used to receive instructions from the controller. For independent control, each fixture must be assigned its own control channels. If you give two MAC Viper Profiles the same address, they will behave identically. Address sharing can be useful for diagnostic purposes and symmetrical control, particularly when combined with the inverse pan and tilt options.

DMX addressing is limited, depending which DMX mode the fixture is in, to make it impossible to set the DMX address so high that you are left without enough control channels for the fixture.

DMX address setting

To set the fixture's DMX address:

1. Click the jog wheel to enter the main menu.
2. Click the jog wheel to enter **DMX ADDRESS**, then rotate the jog wheel to scroll to the desired address and click the jog wheel to save.
3. Press the Escape button to step back to the main menu.

DMX modes

The **CONTROL MODE** menu lets you set the MAC Viper Profile to one of the two DMX operating modes, basic 16-bit and extended 16-bit:

- Basic 16-bit mode offers coarse control of all effects plus fine control of gobo indexing angle on both gobo wheels, pan and tilt.
- Extended 16-bit mode provides all the features of basic 16-bit mode plus fine control of the dimmer, zoom and focus.

The MAC Viper Profile uses 26 DMX channels in basic 16-bit mode and 34 DMX channels in extended 16-bit mode.

To set the fixture's DMX mode:

1. Click the jog wheel to enter the main menu.
2. Rotate the jog wheel to scroll down to **CONTROL MODE**, then click the jog wheel. Rotate the jog wheel to select either **BASIC** or **EXTENDED**, then click the jog wheel to save.
3. Press the Escape button to step back to the main menu.

Fixture ID

The MAC Viper Profile lets you set a four-digit ID number to ease identification of the fixtures in an installation. When a fixture is powered on for the first time, it displays its DMX address by default. As soon as you set an ID number other than **0** in **FIXTURE ID**, the MAC Viper Profile will display this ID number by default, and indicate **FIXTURE ID** in the display.

Personality

The MAC Viper Profile provides several options that let you optimize the fixture for different applications in the **PERSONALITY** menu:

- The **PAN/TILT** menu lets you swap and/or invert pan and tilt.
- The **SPEED** menu lets you set **PAN/TILT** to **NORMAL**, **FAST** (optimized for speed) or **SLOW** (optimized for smooth movement – useful for slow movements in long-throw applications). Likewise, you can select an overall speed for all the effects by setting **EFFECT** speed to **NORMAL**, **FAST** or **SLOW**. You can also set effect speed to **FOLLOW P/T**, in which effects will always use whatever speed is set for pan and tilt.
- **DIMMER CURVE** provides four dimming options (see Figure 5):

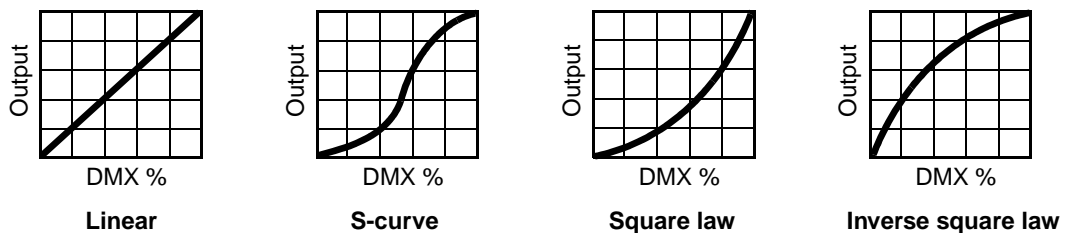

Figure 5: Dimming curve options

- **LINEAR** – (optically linear) the increase in light intensity appears to be linear as DMX value is increased.
- **S-CURVE** – light intensity control is finer at low levels and high levels and coarser at medium levels. This curve emulates the RMS voltage dimming characteristics of an incandescent lamp such as the tungsten halogen lamp of the Martin™ MAC TW1™.
- **SQUARE LAW** – light intensity control is finer at low levels and coarser at high levels.
- **INV SQUARE LAW** – light intensity control is coarser at low levels and finer at high levels.
- **FOCUS TRACKING** sets focus to automatically switch between the three zoom/focus settings when you use the zoom effect (see “Zoom/focus linking” on page 7).
- **GOBO 3 FX RANGE** sets the range of positions available on the FX wheel. It is intended to let you restrict the FX wheel so that only the gobo range or only the gobo animation range is active.
- **AUTO LAMP ON** gives three lamp strike options:
 - When set to **OFF**, the lamp remains off until a “lamp on” command is received via DMX.
 - When set to **ON**, the lamp strikes automatically after the fixture is powered on.
 - When set to **DMX**, the lamp strikes automatically when the fixture begins to receive DMX data, and lamp power is shut down 15 minutes after the fixture stops receiving DMX data. Automatic lamp strikes are staggered to prevent all lamps from striking at once. The delay is determined by the fixture address. No matter what the **AUTOMATIC LAMP ON** setting is, the lamp can be struck by sending a lamp on command via DMX on channel 26 in basic mode or 29 in extended mode.
- **DMX LAMP OFF** and **DMX RESET** define whether the lamp can be powered off, or whether fixture or individual effects can be reset by sending a DMX command on channel 26 in 16-bit mode or 29 in 16-bit extended mode. If either of these settings are set to **Off**, you can override this setting and cut lamp power or reset effects by applying a special combination of DMX values (see “DMX protocol” on page 20).

- **EFFECT SHORTCUT** determines whether the gobo wheels and color wheel take the shortest path between two positions (shortcuts enabled), crossing the open position if necessary, or always avoid the open position (shortcuts disabled).
- **AUTO BLACKOUT** lets you set two effects to deploy 5 seconds after a shutter/dimmer blackout to eliminate any stray light. When enabled, the iris closes and the aerial wheel moves to the nearest available position between two slots. This ensures a highly effective blackout, but snapping open from blackout is not quite as fast because of the time it takes the effects to move away from their auto blackout positions.
- **DISPLAY** offers the following options for the LCD display:
 - **DISPLAY SLEEP** determines whether the display remains on permanently, or goes into sleep mode 2, 5 or 10 minutes after the last movement of the jog wheel or Escape button.
 - **DISPLAY INTENSITY** lets you define the brightness of the display backlighting. Select **Auto** for automatic adjustment to match the ambient light level, or manually set the intensity to a level from 0% to 100%.
 - **DISPLAY ROTATION** lets you rotate the display manually through 0°, 90°, 180° or 270° so that it can be read easily no matter how the fixture is oriented. If set to **Auto**, the MAC Viper Profile senses its orientation and rotates the display automatically.
 - **DISPLAY CONTRAST** lets you define the contrast of the backlit graphic display. Select **Auto** for automatic adjustment to match display intensity, or manually set the contrast to a level from 0% to 100%.
- **ERROR MODE** enables or disables error warnings. If set to **NORMAL**, the display is activated and lights up if the fixture needs to report an error. If set to **SILENT**, the fixture does not light the display with error warnings but error messages can still be read when the display is activated manually. In both **NORMAL** and **SILENT** modes, the status LED lights amber to indicate a warning and red to indicate an error.

Factory defaults

FACTORY DEFAULT lets you reload the fixture's factory default settings. Effect calibration is not affected, so any effects that have been re-calibrated will not be returned to factory calibration settings.

Fixture information readouts

The following fixture information can be called up in the display:

- **POWER ON TIME** provides two counters:
 - The **TOTAL** counter is not user-resettable and displays total hours powered on since manufacture.
 - The **RESETTABLE** counter is user-resettable and displays the number of hours the fixture has been powered on since the counter was last reset.
- **LAMP ON TIME** provides two counters:
 - The **TOTAL** counter is not user-resettable and displays total hours the lamp has been powered on since manufacture.
 - The **RESETTABLE** counter is user-resettable and displays the number of hours the lamp has been powered on since the counter was last reset. This counter is intended to allow you to monitor lamp life.
- **LAMP STRIKES** provides two counters:
 - The **TOTAL** counter is not user-resettable and displays the total number of lamp strikes since manufacture.
 - The **RESETTABLE** counter is user-resettable and displays the number of lamp strikes since the counter was last reset.
- **SW VERSION** displays the currently installed firmware (fixture software) version.
- **SERIAL NUMBER** displays the fixture's manufacturer serial number.
- **RDM UID** displays the fixture's factory-set unique ID for identification in RDM systems.
- **FAN SPEEDS** provides separate status readouts from the fixture's cooling fans.
- **TEMPERATURES** provides separate PCB temperature readouts.

DMX signal monitoring

The MAC Viper Profile provides data on the DMX signal it is receiving in the **DMX LIVE** menu. This information can be useful for troubleshooting control problems.

RATE displays the DMX refresh rate in packets per second. Values lower than 10 or higher than 44 may result in erratic performance, especially when using tracking control.

QUALITY displays the quality of the received DMX data as a percentage of packets received. Values much below 100 indicate interference, poor connections, or other problems with the serial data link that are the most common cause of control problems.

START CODE displays the DMX start code. Packets with a start code other than 0 may cause irregular performance.

The remaining options under **DMX LIVE** display the DMX values in a range from 0 - 255 that are being received on each channel. The DMX channels displayed depend on whether the fixture is in 16-bit or 16-bit extended mode.

Test sequences

TEST activates effects in sequence, allowing you to test all effects, pan and tilt movement only, or effects only (i.e. without pan and tilt movement) without a DMX controller:

- Select a test type and click on the jog wheel to start the test.
- Click on the Escape button to stop the test.

Manual control

The **MANUAL CONTROL** menu lets you reset the MAC Viper Profile, strike or douse the lamp, and operate the fixture without a DMX controller. To execute commands in the **MANUAL CONTROL** menu, select a menu item for the effect that you want to control, then enter a value from 0 to 255 to apply a command. The menu items and values correspond to the commands listed in the DMX protocol on page 20.

Adjusting settings via DMX

Certain fixture settings and parameters can be adjusted from the DMX controller on the fixture control DMX channel 26 in basic 16-bit mode or channel 29 in extended 16-bit mode.

Commands sent on the fixture control channel override any settings entered in the fixture's onboard control menus.

To help you avoid accidentally applying a setting that may disrupt a light show, for example, most of the commands must be held for a certain time before they are applied. For example, the command that turns off the display illumination must be held for one second to activate it. The command that resets the fixture must be held for five seconds to activate it. The times required to apply DMX commands on the fixture control channel are listed for each command on page 26 in the DMX protocol.

Resetting

Either the entire fixture or individual effects can be reset to their initial positions. Resetting individual effects can allow on-the-fly recovery if an effect loses its correct position, for example, without having to reset the entire fixture.

Lamp on / off

The lamp can be struck and doused from the DMX controller.

A peak of electric current that is many times the operating current is drawn for a fraction of a second when striking a discharge lamp. Striking many lamps at once may cause a voltage drop large enough to prevent lamps from striking or draw enough current to trip electronic circuit breakers. If sending lamp-on commands to multiple fixtures, program a sequence that strikes lamps one at a time.

Illuminating the display

The fixture's display panel can be brought out of sleep mode with a DMX command. This makes it possible to read the fixture's DMX address while the fixture is installed in the rig.

After being illuminated in this way, the display will return to sleep mode according to the setting entered in the onboard control menus.

Control menu setting overrides

The following fixture settings can be adjusted via DMX, overriding the settings entered in the onboard control menus. See under "Effects" on page 5 for details of these settings.

- Dimming curve
- Pan and tilt speed
- Effect shortcuts
- Zoom/focus linking
- Ballast output
- Calibration offsets

RDM

The MAC Viper Profile can communicate using RDM (Remote Device Management) in accordance with ESTA's *American National Standard E1.20-2006: Entertainment Technology RDM Remote Device Management Over DMX512 Networks*.

RDM is a bi-directional communications protocol for use in DMX512 control systems, it is the open standard for DMX512 device configuration and status monitoring.

The RDM protocol allows data packets to be inserted into a DMX512 data stream without adversely affecting existing non-RDM equipment. The RDM protocol allows a console or dedicated RDM controller to send commands to and receive messages from specific fixtures.

RDM ID

Each MAC Viper Profile has a factory-set RDM UID (unique identification number) that makes it addressable and identifiable in RDM systems. The number can be found in the control panel **INFORMATION** menu under **RDM UID**.

RDM communication

The MAC Viper Profile is RDM (Remote Device Management) compliant. As standard, it supports a range of RDM PIDs (Parameter IDs). Sending **SUPPORTED_PARAMETERS** and **PARAMETER_DESCRIPTION** commands from an RDM controller will call up a list of the PIDs it supports.

Software service functions

Service utilities

The control panel **SERVICE** menu provides utilities for technicians rigging or servicing the fixture:

- **ERROR LIST** displays any error messages that are stored in internal memory.
- **PT FEEDBACK** lets you disable feedback to the fixture software from the pan, tilt and effects positioning systems. If feedback is set to **ON** and a pan, tilt or effect position error is detected, the shutter closes and the effect resets. This feature can be disabled by setting feedback to **OFF**.
The **OFF** setting is not saved when the fixture is powered off, and the system will be re-enabled the next time the fixture starts. If a pan/tilt position error occurs and the system cannot correct pan/tilt position within 10 seconds, feedback is automatically disabled.
- **ADJUST** is for use at the factory and by authorized Martin Service technicians only. This menu allows dimmer and frost positions to be adjusted after replacement of components, etc. To adjust the default positions of all the MAC Viper Profile's effects, use the **CALIBRATION** menu instead.

Important! *Do not enter the ADJUST menu without service documentation from Martin.*

- **CALIBRATION** lets you set new default positions for calibration purposes, set effects to their factory default positions or overwrite the factory default positions with new values. See "Calibration" below.
- **USB** lets you update the firmware (fixture software) using a USB memory device. For a detailed guide to updating the firmware, see "Installing using a USB memory device" later in this chapter.

Calibration

The **CALIBRATION** menu lets you define offsets in software that are relative to the mechanical reset or home positions. This allows you to fine-tune optical alignment and achieve uniform performance between fixtures. Fixtures are adjusted and calibrated at the factory, and further calibration will normally only be necessary if fixtures have been subjected to abnormal shocks during transport or if normal wear and tear has affected alignment after an extended period of use.

Calibrating pan and tilt sensors

Warning! *Be ready for the head to move during pan and tilt calibration.*

To calibrate pan and tilt:

1. Place the fixture on a stable surface.
2. Select **PT AT END STOP**.
3. Move pan to its end stop position by rotating the yoke *clockwise* (as seen from above the head looking towards the base) to maximum pan.
4. Move tilt to its end stop by tilting the head to its maximum angle with the front glass pointing towards the base and away from the display/control panel.
5. Be ready for the head to move. Click the jog wheel to register the positions. The fixture will display **Saving...** and the head will move.
6. Press the Escape button to exit pan/tilt sensor calibration.

Loading and storing default calibration offsets

In the **CALIBRATION** menu, **LOAD DEFAULTS** lets you load the factory default calibration offsets stored in memory.

SAVE DEFAULTS lets you overwrite the factory default calibration offsets stored in memory with any new offsets that you have defined. Overwriting is permanent, so once you have saved new default offsets, **LOAD DEFAULTS** will reload the new offsets.

Firmware installation

The currently installed firmware (fixture software) version can be viewed in the control panel **INFORMATION** menu. Firmware updates are available from the Martin™ website and can be installed using a USB memory stick or a Windows PC running the Martin Uploader application and either a Martin Universal USB Duo™ USB-DMX interface device or a Martin DABS1™ USB-DMX interface device.

Calibration data is stored in the relevant modules wherever possible so that a module will stay calibrated if it is removed from the fixture or installed in another fixture.

Do not switch the fixture off during a firmware update, or firmware will be corrupted.

Installing using a USB memory device

The following are required in order to install firmware using a USB memory device:

- The MAC Viper Profile '.BANK' firmware update file, available for download from the Martin website at <http://www.martin.com>.
- A USB memory stick with the update file copied from a PC into the USB stick's root directory.

To install the MAC Viper Profile firmware:

1. Download the '.BANK' firmware file from the MAC Viper Profile Product Support page at www.martin.com, read the firmware release notes carefully to check for any instructions or warnings, and copy the firmware file to the root directory of a USB stick.
2. Disconnect the data link from the MAC Viper Profile.
3. Insert the USB stick in the MAC Viper Profile's USB host socket. The fixture should recognize the USB stick, illuminate the display and show **UPDATING FILES** in the display while it checks and if necessary updates its internal memory with new firmware versions stored on the USB stick. If the fixture does not recognize the USB stick, scroll to the **USB** menu under **SERVICE** in the control panel.

Important! *Do not remove a USB memory device while the fixture is updating files.*

4. When the fixture has updated its internal memory, **AVAILABLE FIRMWARE** will appear in the display. You can now scroll through the firmware versions available in memory.
5. To install a firmware version, select it by scrolling and then clicking with the jog wheel. The MAC Viper Profile asks you to confirm installation of the new firmware. If you do not want to install that version, press the Escape button.
6. Allow the fixture to install the firmware and reboot.
7. Remove the USB stick. The newly-installed firmware version will now be displayed in the **INFORMATION** menu.
8. Reconnect the data link.
9. If you have installed a new firmware version, check the Martin™ website to see whether an updated User Guide is available for this firmware.

Fixture information and settings, including zoom-focus linking, are not affected when new software is uploaded.

Installing using a PC and hardware interface

The following are required in order to install firmware using a PC:

- The MAC Viper Profile firmware '.MU3' update file, available for download from the Product Support area of the Martin website at <http://www.martin.com>.
- A Windows PC running the latest version of the Martin Uploader™ application (also available for download free of charge from www.martin.com) and loaded with the firmware update file.
- A USB-DMX hardware interface device such as the Martin USB Duo™ or Martin DABS1™.

To install the MAC Viper Profile firmware:

1. Download the firmware '.MU3' file from the MAC Viper Profile support page on the Martin website to the PC.
2. Read the firmware release notes carefully to check for any instructions or warnings.
3. Follow the instructions for an auto upload/upload via DMX in the Martin Uploader application help files and supplied with the hardware interface.

DMX protocol

Applicable when running MAC Viper Profile firmware version: 1.1.0

Basic 16-bit Mode	16-bit Extended Mode	DMX Value	Percent	Function	Fade type	Default value
1	1	0 - 19	0 - 7	Strobe/shutter Shutter closed (Lamp switches to 800 watt mode after shutter is closed for 10 seconds)	Snap	30
		20 - 49	8 - 19	Shutter open		
		50 - 200	20 - 78	Strobe, slow → fast		
		201 - 210	79 - 82	Shutter open		
		211 - 255	82 - 100	Random strobe, slow → fast		
2	2	0 - 65535	0 - 100	Dimmer fade (MSB) Closed → open	Fade	0
	3			Dimmer fade, fine (LSB)	Fade	0
3	4	0 - 255	0 - 100	Cyan White → full cyan	Fade	0
4	5	0 - 255	0 - 100	Magenta White → full magenta	Fade	0
5	6	0 - 255	0 - 100	Yellow White → full yellow	Fade	0
6	7	0 - 255	0 - 100	CTO Open (6000 K) → warm (3200 K)	Fade	0

Table 1: DMX Protocol

Basic 16-bit Mode	16-bit Extended Mode	DMX Value	Percent	Function	Fade type	Default value		
7	8			Color Wheel				
				<i>Continuous Scroll</i>				
		0	0	Open				
		1 - 14	1 - 5	Open → Slot 1				
		15	6	Slot 1				
		16 - 29	6 - 11	Slot 1 → Slot 2				
		30	12	Slot 2				
		31 - 44	12 - 17	Slot 2 → Slot 3				
		45	18	Slot 3				
		46 - 59	18 - 23	Slot 3 → Slot 4				
		60	23	Slot 4				
		61 - 74	24 - 29	Slot 4 → Slot 5				
		75	29	Slot 5				
		76 - 89	30 - 35	Slot 5 → Slot 6				
		90	35	Slot 6				
		91 - 104	36 - 41	Slot 6 → Slot 7				
		105	41	Slot 7				
		106 - 119	41 - 46	Slot 7 → Slot 8				
		120	47	Slot 8				
		121 - 134	47 - 52	Slot 8 → Open				
		135 - 140	53 - 55	Open		Snap	0	
						<i>Stepped Scroll (snap to full color positions)</i>		
				141 - 145	55 - 57	Slot 1		
				146 - 150	57 - 59	Slot 2		
				151 - 155	59 - 61	Slot 3		
				156 - 160	61 - 63	Slot 4		
				161 - 165	63 - 64	Slot 5		
				166 - 170	65 - 66	Slot 6		
				171 - 175	67 - 68	Slot 7		
				176 - 180	69 - 70	Slot 8		
				181 - 185	71 - 73	Open		
						<i>Continuous Rotation</i>		
		186 - 211	73 - 82	CW, Fast → Slow				
		212 - 217	83 - 85	Stop (This will stop the color wheel wherever it is at the time)				
		218 - 243	85 - 95	CCW, Slow → Fast				
				<i>Random color</i>				
		244 - 247	95 - 96	Fast				
		248 - 251	97 - 98	Medium				
		252 - 255	98 - 100	Slow				

Table 1: DMX Protocol

Basic 16-bit Mode	16-bit Extended Mode	DMX Value	Percent	Function	Fade type	Default value
8	9	0 - 9	0 - 4	Breakup wheel (wheel 1): gobo selection, indexing, shake, rotation <i>Indexed gobo: set indexed angle on channels 9/10 (16-bit) or 10/11 (16-bit ext.)</i> Open	Snap	0
		10 - 14	4 - 5	Gobo 1		
		15 - 19	5 - 8	Gobo 2		
		20 - 24	8 - 10	Gobo 3		
		25 - 29	10 - 12	Gobo 4		
		30 - 34	12 - 13	Gobo 5		
		35 - 39	14 - 16	<i>Continuous gobo rotation: set gobo rotation speed on channels 9/10 (16-bit) or 10/11 (16-bit ext.)</i> Gobo 1		
		40 - 44	16 - 17	Gobo 2		
		45 - 49	18 - 19	Gobo 3		
		50 - 54	20 - 21	Gobo 4		
		55 - 59	21 - 23	Gobo 5		
		60 - 89	23 - 35	<i>Gobo shake centered on indexed position: set indexed angle on channels 9/10 (16-bit) or 10/11 (16-bit ext.). Shake angle increments in following steps: 10°, 15°, 30°, 45°, 60°, 90°, 135°, 180°, 270° and 360°</i> Gobo 1, 360° slow → 10° fast		
		90 - 119	35 - 46	Gobo 2, 360° slow → 10° fast		
		120 - 149	47 - 58	Gobo 3, 360° slow → 10° fast		
150 - 179	59 - 70	Gobo 4, 360° slow → 10° fast				
180 - 209	70 - 82	Gobo 5, 360° slow → 10° fast				
210 - 232	82 - 91	<i>Continuous gobo wheel scroll with continuous gobo rotation: set gobo rotation speed on channels 9/10 (16-bit) or 10/11 (16-bit extended)</i> CW gobo wheel scroll, fast → slow				
233 - 255	91 - 100	CCW gobo wheel scroll, slow* → fast				
9	10	0 - 65535	0 - 100	Breakup wheel (wheel 1): gobo indexing, rotation (16-bit fine, MSB and LSB) <i>If indexed gobo is selected on channel 8 (16-bit) or 9 (16-bit ext.)</i> Gobo indexing, 0° → maximum	Fade	32768
		0 - 600	0	<i>If continuous gobo rotation is selected on channel 8 (16-bit) or 9 (16-bit ext.)</i> No gobo rotation, gobo indexed at 0°		
10	11	601 - 32130	1 - 49	No gobo rotation, gobo indexed at 0°	Fade	32768
		32131 - 32895	49 - 50	CW, fast → slow		
		32896 - 64515	50 - 99	No gobo rotation, gobo stops at current position		
		64516 - 65535	100	CCW, slow → fast No gobo rotation, gobo indexed at 90°		

Table 1: DMX Protocol

Basic 16-bit Mode	16-bit Extended Mode	DMX Value	Percent	Function	Fade type	Default value
11	12	0 - 9	0 - 4	Aerial wheel (wheel 2): gobo selection, indexing, shake, rotation <i>Indexed gobo: set indexed angle on channels 12/13 (16-bit) or 13/14 (16-bit ext.)</i> Open	Snap	0
		10 - 14	4 - 5	Gobo 1		
		15 - 19	5 - 8	Gobo 2		
		20 - 24	8 - 10	Gobo 3		
		25 - 29	10 - 12	Gobo 4		
		30 - 34	12 - 14	Gobo 5		
		35 - 39	14 - 16	<i>Continuous gobo rotation: set gobo rotation speed on channels 12/13 (16-bit) or 13/14 (16-bit ext.)</i> Gobo 1		
		40 - 44	16 - 18	Gobo 2		
		45 - 49	18 - 20	Gobo 3		
		50 - 54	20 - 22	Gobo 4		
		55 - 59	22 - 24	Gobo 5		
		60 - 89	24 - 34	<i>Gobo shake centered on indexed position: set indexed angle on channels 12/13 (16-bit) or 13/14 (16-bit ext.). Shake angle increments in following steps: 10°, 15°, 30°, 45°, 60°, 90°, 135°, 180°, 270° and 360°</i> Gobo 1, 360° slow → 10° fast		
		90 - 119	35 - 45	Gobo 2, 360° slow → 10° fast		
		120 - 149	46 - 56	Gobo 3, 360° slow → 10° fast		
150 - 179	57 - 67	Gobo 4, 360° slow → 10° fast				
180 - 209	68 - 78	Gobo 5, 360° slow → 10° fast				
210 - 232	79 - 89	<i>Continuous gobo wheel scroll with continuous gobo rotation: set gobo rotation speed on channels 12/13 (16-bit) or 13/14 (16-bit extended)</i> CW gobo wheel scroll, fast → slow				
233 - 255	90 - 100	CCW gobo wheel scroll, slow* → fast				
12	13	0 - 65535	0 - 100	Aerial wheel (wheel 2): gobo indexing, rotation (16-bit fine, MSB and LSB) <i>If indexed gobo is selected on channel 11 (16-bit) or 12 (16-bit ext.)</i> Gobo indexing, 0° → maximum	Fade	32768
				<i>If continuous gobo rotation is selected on channel 11 (16-bit) or 12 (16-bit ext.)</i>		
13	14	0 - 600	0	No gobo rotation, gobo indexed at 0°		
		601 - 32130	1 - 49	CW, fast → slow		
		32131 - 32895	49 - 50	No gobo rotation, gobo stops at current position		
		32896 - 64515	50 - 99	CCW, slow → fast		
64516 - 65535	100	No gobo rotation, gobo indexed at 90°				

Table 1: DMX Protocol

Basic 16-bit Mode	16-bit Extended Mode	DMX Value	Percent	Function	Fade type	Default value	
14	15	FX wheel (wheel 3) static gobos and animation effect selection, rotation, animation movement type				Fade	0
		<i>Continuous FX wheel scrolling</i>					
		0	0	Open			
		1 - 9	0 - 4	Open → Gobo 1			
		10	4	Gobo 1			
		11 - 19	4 - 7	Gobo 1 → Gobo 2			
		20	8	Gobo 2			
		21 - 29	8 - 11	Gobo 2 → Gobo 3			
		30	12	Gobo 3			
		31 - 39	12 - 15	Gobo 3 → Gobo 4			
		40	16	Gobo 4			
		41 - 49	16 - 19	Gobo 4 → Position 5			
		50	20	Position 5			
		51 - 59	20 - 23	Position 5 → Position 6			
		60	23	Position 6			
		61 - 69	24 - 27	Position 6 → Position 7			
		70	27	Position 7			
		71 - 79	28 - 31	Position 7 → Position 8			
		80	31	Position 8			
		81 - 89	32 - 35	Position 8 → Position 9			
		90	35	Position 9			
		91 - 99	35 - 40	Position 9 → Open			
		100 - 110	39 - 43	Open			
		<i>Stepped FX wheel scrolling</i>					
		111 - 115	43 - 45	Gobo 1			
		116 - 120	46 - 47	Gobo 2			
		121 - 125	47 - 49	Gobo 3			
		126 - 130	49 - 51	Gobo 4			
		131 - 135	51 - 53	Position 5			
		136 - 140	53 - 55	Position 6			
		141 - 145	55 - 57	Position 7			
		146 - 150	57 - 59	Position 8			
		151 - 155	59 - 61	Position 9			
156 - 160	61 - 63	Open					
<i>Continuous FX wheel rotation: set rotation speed on channel 15 (16-bit) or 16 (16-bit extended)</i>							
161 - 189	63 - 74	CW FX wheel rotation, fast → slow					
190	74	FX wheel stops at its current position					
191 - 219	75 - 86	CCW FX wheel rotation, slow* → fast					
220 - 226	86 - 88	No function					
<i>Animation movement functions: set speed on channel 15 (16-bit) or 16 (16-bit extended)</i>							
227 - 229	89	Smooth					
230 - 232	90 - 91	Organic					
233 - 235	91 - 92	Metronome					
236 - 238	92 - 93	Run forwards, fast rewind					
239 - 241	93 - 94	Run backwards, fast rewind					
242 - 243	95	Random bounce					
244 - 246	95 - 96	Interference					
247 - 249	96 - 97	Random animation range position					
250 - 252	98	Random gobo position					
253 - 255	99 - 100	Random FX wheel position					
15	16	Animation speed				Fade	128
		0 - 10	0 - 4	Stop			
		11 - 255	4 - 100	Animation speed slow → fast			
16	17	Frost				Fade	0
		0 - 255	0 - 100	No frost → full frost			
17	18	Prism				Snap	0
		0 - 10	0 - 4	Prism off			
		11 - 138	4 - 54	Prism indexing: set angle on ch. 18 (16-bit) or 19 (16-bit ext.)			
		139 - 255	54 - 100	Prism rotation: set direction and speed on ch. 18 (16-bit) or 19 (16-bit ext.)			

Table 1: DMX Protocol

Basic 16-bit Mode	16-bit Extended Mode	DMX Value	Percent	Function	Fade type	Default value
18	19	0 - 255	0 - 100	Prism indexing angle, rotation speed and direction <i>If prism indexing is selected on channel 17 (16-bit) or 18 (16-bit ext.):</i> Indexed angle 0° - maximum	Fade	128
		0 - 2	0	<i>If prism rotation is selected on channel 17 (16-bit) or 18 (16-bit ext.):</i> Prism stop, indexed at 0°		
		3 - 126	1 - 50	CW rotation, fast → slow		
		127 - 129	51	Prism stop at its current position		
		130 - 253	52 - 99	CCW rotation, slow → fast		
		254 - 255	100	Prism stop, indexed at 45°		
19	20	0 - 255	0 - 100	Iris Open → closed	Fade	0
20	21	0 - 65535	0 - 100	Zoom, 16-bit (MSB and LSB) Flood → spot	Fade	32768
	22					
21	23	0 - 65535	0 - 100	Focus, 16-bit (MSB and LSB) Infinity → near	Fade	32768
	24					
22	25	0 - 65535	0 - 100	Pan, 16-bit (MSB and LSB) Left → right (32768 = neutral)	Fade	32768
23	26					
24	27	0 - 65535	0 - 100	Tilt, 16-bit (MSB and LSB) Up → down (32768 = neutral)	Fade	32768
25	28					

Table 1: DMX Protocol

Basic 16-bit Mode	16-bit Extended Mode	DMX Value	Percent	Function	Fade type	Default value
26	29			Fixture control/settings (hold for number of seconds indicated to activate)	Snap	0
		0 - 9	0 - 4	No function (disables calibration) – 5 sec.		
		10 - 14	4 - 5	Reset entire fixture – 5 sec.		
		15 - 19	6 - 7	Reset dimmer and shutter only – 5 sec.		
		20 - 24	8 - 9	Reset CMY, CTO and color wheel only – 5 sec.		
		25 - 29	10 - 11	Reset effects (breakup, aerial and FX wheels, iris, prism, frost, zoom, focus) only – 5 sec.		
		30 - 34	12 - 13	Reset pan and tilt only – 5 sec.		
		35 - 39	14 - 15	No function		
		40 - 44	16 - 17	Lamp on		
		45 - 49	18 - 19	Lamp off – 5 sec.		
		50 - 54	20 - 21	No function		
		55 - 59	21 - 23	Enable calibration – 5 sec.		
		60 - 64	23 - 25	Linear dimming curve – 1 sec. (menu override, setting unaffected by power off/on)		
		65 - 69	25 - 27	Square law dimming curve – 1 sec. (menu override, factory default setting, setting unaffected by power off/on)		
		70 - 74	28 - 29	Inverse square law dimming curve – 1 sec. (menu override, setting unaffected by power off/on)		
		75 - 79	29 - 31	S-curve dimming curve – 1 sec. (menu override, setting unaffected by power off/on)		
		80 - 84	32 - 33	Normal pan and tilt speed – 1 sec. (menu override - setting returns to MENU setting after power on/off)		
		85 - 89	34 - 35	Fast pan and tilt speed – 1 sec. (default setting, menu override - setting returns to MENU setting after power on/off)		
		90 - 94	35 - 37	Slow pan and tilt speed – 1 sec. (menu override - setting returns to MENU setting after power on/off)		
		95 - 99	37 - 39	Effect shortcuts = ON – 1 sec. (default setting, menu override, setting stays at factory default ON at power off/on)		
		100 - 104	39 - 41	Effect shortcuts = OFF – 1 sec. (menu override, setting returns to factory default ON at power off/on)		
		105 - 109	41 - 43	Disable zoom/focus linking – 1 sec.		
		110 - 114	43 - 45	Enable zoom/focus linking, near distance – 1 sec.		
		115 - 119	45 - 46	Enable zoom/focus linking, medium distance (default setting) – 1 sec.		
		120 - 124	47 - 48	Enable zoom/focus linking, far distance – 1 sec.		
		125 - 126	49	Ballast output full, set to 100% (default setting)		
		127 - 128	50	Ballast output reduced to 90%		
		129 - 130	50 - 51	Ballast output reduced to 80%		
		131 - 132	51 - 52	Ballast output reduced to 70%		
		133 - 134	52	Ballast output reduced to 60%		
		135 - 139	53 - 54	Beam smoothing = ON – 1 sec.		
		140 - 144	55 - 56	Beam smoothing = OFF – 1 sec. (default setting)		
		145 - 149	57 - 58	No function		
		150 - 154	59 - 60	Illuminate display – 1 sec.		
		155 - 159	61 - 62	Turn off display		
		160 - 164	62 - 63	No function		
		165 - 169	64 - 66	Store pan and tilt calibration – 5 sec.		
		170 - 174	66 - 68	Store dimmer calibration – 5 sec.		
		175 - 179	68 - 70	Store cyan calibration – 5 sec.		
		180 - 184	70 - 72	Store magenta calibration – 5 sec.		
		185 - 189	72 - 74	Store yellow calibration – 5 sec.		
		190 - 194	74 - 76	Store CTC calibration – 5 sec.		
		195 - 199	76 - 78	Store all CMY and CTC calibration – 5sec.		
		200 - 204	78 - 80	Store breakup wheel (wheel 1)/current slot index calibration – 5 sec.		
		205 - 209	80 - 82	Store aerial wheel (wheel 2)/current slot index calibration – 5 sec.		
		210 - 214	82 - 84	Store FX wheel (wheel 3) calibration – 5 sec.		
		215 - 219	84 - 86	Store beam effect (prism) index calibration – 5 sec.		
		220 - 224	86 - 88	Store iris calibration – 5 sec.		
225 - 229	88 - 89	Store focus calibration – 5 sec.				
230 - 234	90 - 91	Store zoom calibration – 5 sec.				
235 - 239	92 - 93	Store pan calibration – 5 sec.				
240 - 244	94 - 95	Store tilt calibration – 5 sec.				
245 - 249	96 - 97	Reset all calibration values to factory defaults – 5 sec.				
250 - 255	98 - 100	No function				
-	30			Reserved for future use		

Table 1: DMX Protocol

Basic 16-bit Mode	16-bit Extended Mode	DMX Value	Percent	Function	Fade type	Default value
-	31			Reserved for future use		
-	32			Reserved for future use		
-	33			Reserved for future use		
-	34			Reserved for future use		

Table 1: DMX Protocol

MSB = Most significant byte

LSB = Least significant byte

Control panel menus

Applicable when running MAC Viper Profile firmware version 1.1.0.

Menus marked* are available only when the fixture is connected to mains power. All other menus are available in mains and battery power operation.

Menu level 1	Menu level 2	Menu level 3	Menu level 4	Notes (Default settings in bold print)	
DMX ADDRESS	1 – XXX			DMX address (default address = 1). The DMX address range is limited so that the fixture will always have enough DMX channels within the 512 available.	
CONTROL MODE	BASIC			16-bit basic DMX mode with 2-channel (coarse and fine) control of breakup and aerial wheel gobo indexing and speed, pan and tilt	
	EXTENDED			16-bit extended DMX mode with basic mode features plus fine control of dimmer, zoom and focus. Five channels are also reserved for future effects.	
FIXTURE ID	0 – 9999	User-settable fixture ID number		0	
PERSONALITY	PAN/TILT	PT SWAP	ON/OFF	Map DMX pan control to tilt channel and vice versa	
		PAN INVERT	ON/OFF	Reverse DMX pan control: right → left	
		TILT INVERT	ON/OFF	Reverse DMX tilt control: down → up	
	SPEED	PAN/TILT	NORMAL		Normal speed pan and tilt
			FAST		Optimize pan/tilt movement for speed
			SLOW		Optimize pan/tilt movement for smoothness
		EFFECT	FOLLOW P/T		Effects speed follows the speed setting applied to pan and tilt via DMX or in control menu
			NORMAL		Normal effects speed
			FAST		Optimize effects movement for speed
	DIMMER CURVE	S-CURVE	LINEAR		Optically linear dimming curve
			SQUARE LAW		Square law dimming curve
			INV SQ LAW		Inverse square law dimming curve
			S-CURVE		S-curve (fixture emulates incandescent lamp voltage linear RMS dimming curve)
	FOCUS TRACKING	Far	Disabled		Disables zoom focus linking
			Near		Enables zoom focus linking, optimized for short-throw projection (5 - 10 m)
			Medium		Enables zoom focus linking, optimized for medium-throw projection (10 - 20 m)
			Far		Enables zoom focus linking, optimized for long-throw projection (20+ m)
GOBO 3 FX RANGE	START FX POS	POSITION OFF, POSITION 1 ... POSITION 8		Defines FX wheel (wheel 3) start position. Default = POSITION 5 .	
	END FX POS	POSITION OFF, POSITION 2 ... POSITION 9		Defines FX wheel (wheel 3) final position. Default = POSITION 9 .	

Table 2: Control menus

Menu level 1	Menu level 2	Menu level 3	Menu level 4	Notes (Default settings in bold print)	
PERSONALITY (continued)	AUTO LAMP ON	OFF		Automatic lamp striking disabled	
		ON		Lamp strikes automatically within 90 seconds of fixture being powered on	
		DMX		Lamp strikes automatically when the fixture receives a DMX signal	
	DMX LAMP OFF	ON		Lamp can be powered off via DMX	
		OFF		Lamp cannot be powered off via DMX (can be overridden: see DMX protocol)	
	DMX RESET	ON		Fixture can be reset via DMX	
		OFF		Fixture cannot be reset via DMX (can be overridden: see DMX protocol)	
	EFFECT SHORTCUT	ON		Effects take shortest route during changes, crossing open positions if necessary	
		OFF		Effects avoid open positions during effects changes	
	AUTO BLACKOUT	OFF		Shutter/dimmer blackout does not call up other effects.	
		ON		Iris and aerial wheel are deployed 5 seconds after shutter/dimmer blackout to eliminate stray light.	
	DISPLAY	DISPLAY SLEEP	ON		Display permanently on
			2 MINUTES		Display goes into sleep mode 2 minutes after last key press
			5 MINUTES		Display goes into sleep mode 5 minutes after last key press
			10 MINUTES		Display goes into sleep mode 10 minutes after last key press
		DISPLAY INTENSITY	10 ... 100		Set display intensity in % (default = 100)
		DISPLAY ROTATION	NORMAL / ROTATE 180		Display orientation normal or rotated 180°
		DISPLAY CONTRAST	1 ...100		Adjust contrast of display (default = 41)
	ERROR MODE	NORMAL		Enable error messages and warnings in display	
		SILENT		Disable error messages and warnings in display (the status LED will still light to indicate fixture status if an error has been detected or the fixture has a warning)	
FACTORY DEFAULT	LOAD FACTORY SETTINGS	ARE YOU SURE?	YES/NO	Return all settings (except calibrations) to factory defaults	

Table 2: Control menus

Menu level 1	Menu level 2	Menu level 3	Menu level 4	Notes (Default settings in bold print)
INFORMATION	POWER ON TIME	TOTAL	0 ... XXX HR	Display hours fixture has been powered on since manufacture (not user-resettable)
		RESETTABLE	CLEAR COUNTER? YES/NO	Display hours fixture has been powered on since last counter reset (user-resettable)
	LAMP ON TIME	TOTAL	0 ... XXX HR	Display hours of lamp use since manufacture (not user-resettable)
		RESETTABLE	CLEAR COUNTER? YES/NO	Display hours of lamp use since last counter reset (user-resettable)
	LAMP STRIKES	TOTAL	0 ... XXX HR	Display number of times lamp has been struck since manufacture (not user-resettable)
		RESETTABLE	CLEAR COUNTER? YES/NO	Display number of times lamp has been struck since last counter reset (user-resettable)
	SW VERSION*	XX.XX.XX		Displays currently active software version
	SERIAL NUMBER*	(XX)XXXXXXXXXXXXXX		Displays fixture's serial number
	RDM UID*	4D50.XXXXXXXXXX		Displays fixture's unique RDM ID
	FAN SPEEDS*	LAMPFAN L ... BASEFAN 4	0 - XXX RPM	Displays current speed of all cooling fans (lamp, head and base)
TEMPERATURES*	ZOOM/FOCUS ... BALLAST	X C	Displays temperature in °C of all PCBs and of ballast capacitor	
DMX LIVE*	RATE	0 - 44 HZ		DMX transmission speed in packets per second
	QUALITY	0 - 100%		Percent of packets received
	START CODE	0 - 255		Value of the DMX start code
	STROBE/SHUTTER ... FX SYNC			Value received on each DMX channel (values for fine control channels can only be viewed if available in the DMX mode the fixture is set to)
TEST*	TEST ALL			Run test sequence of all functions. Press Escape button to stop test
	TEST PAN/TILT			Run test sequence of pan and tilt functions. Press Escape button to stop test
	TEST EFFECTS			Run test sequence of all effects. Press Escape button to stop test

Table 2: Control menus

Menu level 1	Menu level 2	Menu level 3	Menu level 4	Notes (Default settings in bold print)
MANUAL CONTROL*	RESET	RESET		Click jog wheel to reset fixture
	LAMP ON/OFF			Manually strike/douse lamp
	STROBE/SHUTTER	0 - 255		Set shutter/strobe effect (default = 30)
	DIMMER	0 - 255		Set dimmer opening
	DIMMER FINE	0 - 255		Set dimmer opening, fine (LSB)
	CYAN	0 - 255		Add cyan
	MAGENTA	0 - 255		Add magenta
	YELLOW	0 - 255		Add yellow
	CTC	0 - 255		Adjust color temperature control (add warmth)
	COLOR WHEEL	0 - 255		Select color filter
	GOBO W 1 SEL	0 - 255		Select gobo, breakup wheel (wheel 1)
	GOBO W 1 I/R	0 - 255		Adjust gobo indexing/rotation, breakup wheel (wheel 1)
	GOBO W 1 I/R FINE	0 - 255		Adjust gobo indexing/rotation, fine (LSB), breakup wheel (wheel 1)
	GOBO W 2 SEL	0 - 255		Select gobo, aerial wheel (wheel 2)
	GOBO W 2 I/R	0 - 255		Adjust gobo indexing/rotation, aerial wheel (wheel 2)
	GOBO W 2 I/R FINE	0 - 255		Adjust gobo indexing/rotation, fine (LSB), aerial wheel (wheel 2)
	EFFECTS WHEEL	0 - 255		Set FX wheel indexed position
	EFFECTS SPEED	0 - 255		Set FX wheel movement speed
	FROST	0 - 255		Set gobo animation wheel indexing
	PRISM I/R	0 - 255		Set prism indexing/rotation
	PRISM INX	0 - 255		Set prism indexed position
	IRIS	0 - 255		Set iris aperture
	ZOOM	0 - 255		Set zoom (default = 128)
	ZOOM FINE	0 - 255		Set zoom, fine (LSB, default = 128)
	FOCUS	0 - 255		Set focus
	FOCUS FINE	0 - 255		Set focus, fine (LSB, default = 128)
MANUAL CONTROL (continued)*	PAN	0 - 255		Set pan angle (default = 128)
	PAN FINE	0 - 255		Set pan angle, fine (LSB, default = 128)
	TILT	0 - 255		Set tilt angle (default = 128)
	TILT FINE	0 - 255		Set tilt angle, fine (LSB, default = 128)
	FX 1	0 - 255		Reserved for future use
	FX 1 ADJUST	0 - 255		Reserved for future use
	FX 2	0 - 255		Reserved for future use
	FX 2 ADJUST	0 - 255		Reserved for future use
	FX SYNC	0 - 255		Reserved for future use

Table 2: Control menus

Menu level 1	Menu level 2	Menu level 3	Menu level 4	Notes (Default settings in bold print)
SERVICE	ERROR LIST	Empty or up to 20 errors		Display any errors in memory
	FAN CLEAN	ON/OFF		Activate fan cleaning
	PT FEEDBACK	ON		Enable pan/tilt position feedback systems
		OFF		Disable pan/tilt position feedback
	ADJUST	DIMMER	ADJUSTED/ NOT ADJUSTED	For use by qualified service technicians – see Martin service documentation before entering this menu
		FROST	NOT ADJUSTED/ 1 - 255	
	CALIBRATION	PT AT END STOP ... TILT		Set individual effects to calibration positions (approx. +/- 5% offset available)
		LOAD DEFAULTS		Load factory default calibration settings
		SAVE DEFAULTS		Replace factory default calibration settings with current calibration settings
	USB	NO DEVICE		No USB device present or no firmware on USB device
		UPDATING FILES		Fixture updating internal memory from USB device
		AVAILABLE FIRMWARE	VER. 1.0.0 ... VER. X.X.X	Select firmware from versions stored in internal memory: select version, then click on jog wheel and confirm your choice to update

Table 2: Control menus

Service and display messages

The MAC Viper Profile gives service and maintenance information by displaying a large 3- or 4-character short code and a smaller full-text message in the display. The short code is visible at a distance, allowing easier reading with the fixture still in the rig, for example, while the full-text message gives more detailed information.

A complete list of service messages is due to be included in a MAC Viper Profile user documentation update August 2012.



www.martin.com • Olof Palmes Allé 18 • 8200 Aarhus N • Denmark
Tel: +45 8740 0000 • Fax +45 8740 0010

MAC Viper™ Profile

SAFETY AND INSTALLATION MANUAL



Martin®

Dimensions

All measurements are given in millimeters

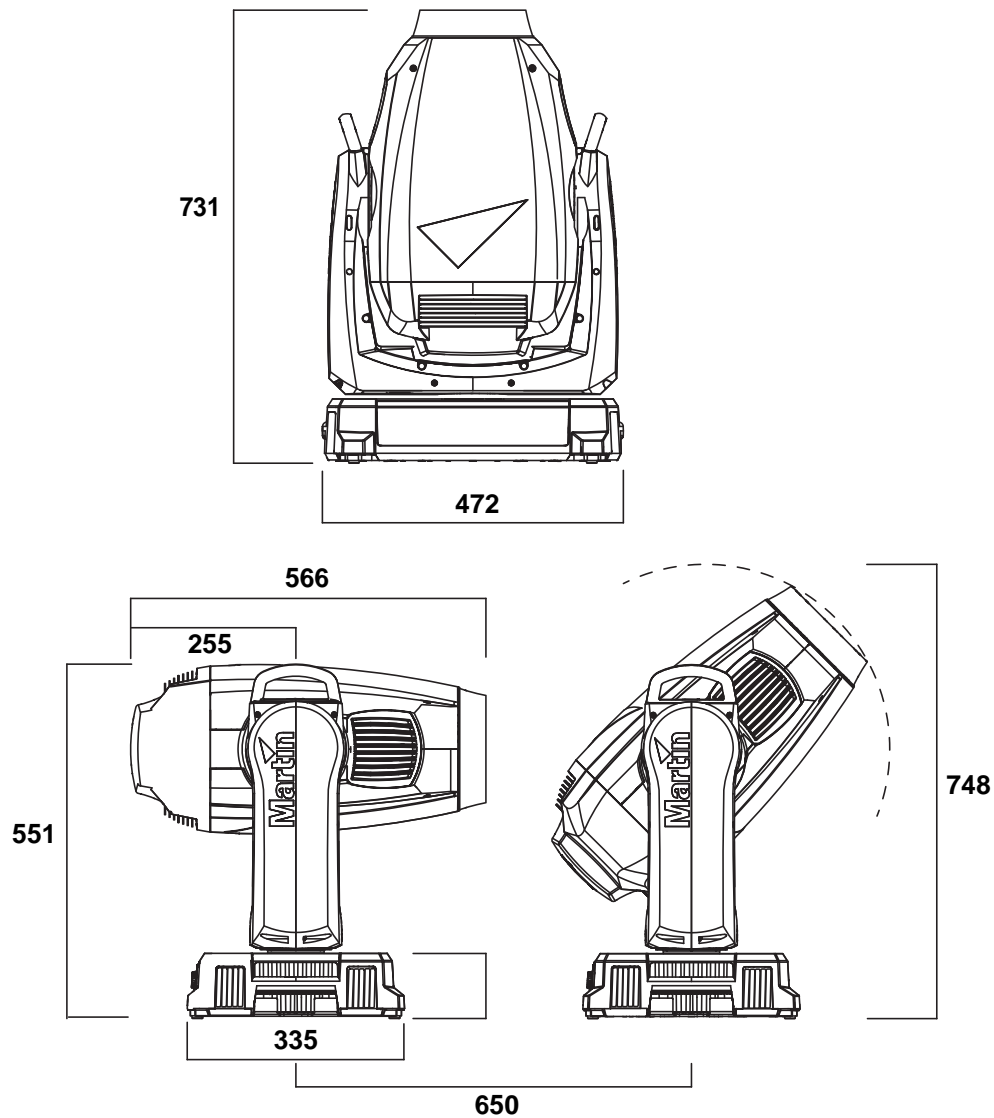

This minimum center-to-center distance can be reduced if pan limits are set via the control menus

© 2012 Martin Professional A/S. Information subject to change without notice. Martin Professional A/S and all affiliated companies disclaim liability for any injury, damage, direct or indirect loss, consequential or economic loss or any other loss occasioned by the use of, inability to use or reliance on the information contained in this document. The Martin logo, the Martin name and all other trademarks in this document pertaining to services or products by Martin Professional A/S or its affiliates and subsidiaries are trademarks owned or licensed by Martin Professional A/S or its affiliates or subsidiaries.

Contents

Safety Information.....	4
Introduction.....	6
Unpacking.....	6
Packing.....	7
Physical installation.....	8
AC power.....	11
Power input.....	11
DMX data link.....	13
Service and maintenance.....	14
Tilt lock.....	14
Lamp.....	14
Access to the head.....	17
Cleaning.....	17
Replacing the head air filters.....	18
Lubrication.....	20
Replacing optical components.....	20
Using the fixture.....	28
Applying power.....	28
Troubleshooting.....	29
Specifications.....	30

Safety Information



WARNING!

Read the safety precautions in this section before installing, powering, operating or servicing this product.

The following symbols are used to identify important safety information on the product and in this document:



DANGER!
Safety hazard.
Risk of severe injury or death.



DANGER!
Refer to manual before installing, powering or servicing.



DANGER!
Hazardous voltage. Risk of severe or lethal electric shock.



Warning!
Fire hazard.



Warning!
Burn hazard. Hot surface. Do not touch.



Warning!
Risk of eye injury. Safety glasses must be worn.



Warning!
Risk of hand injury. Safety gloves must be worn.



Warning! The MAC Viper Profile™ contains components that are accessible and live at high voltage while the fixture is connected to power and that remain under tension for 30 minutes after power is disconnected. Only technicians who are authorized by Martin™ and who have access to the Martin™ service documentation for the MAC Viper Profile are permitted to open the base and yoke of the fixture. The user may open the MAC Viper Profile's head only to carry out the service operations described in this manual, following the warnings and instructions provided.



Warning! Risk Group 3 (high risk) product according to EN 62471. Do not view the light output with optical instruments or any device that may concentrate the beam.



The latest versions of this Safety and Installation Manual and the MAC Viper Profile User Guide are available for download from the MAC Viper Profile Product Support page on the Martin™ website at www.martin.com. Before you install, operate or service the MAC Viper Profile, check the Martin™ website and make sure that you have the latest user documentation for the fixture. Document revisions are indicated at the bottom of page 2. Follow the safety precautions and observe all warnings in this manual, in the MAC Viper Profile User Guide, and printed on the fixture.

This product is for professional use only. It is not for household use.

This product presents risks of severe injury or death due to fire and burn hazards, electric shock, lamp explosion and falls.

Refer any service operation not described in this manual or in the MAC Viper Profile User Guide to Martin™ Service or an authorized Martin™ Service partner.

If you have questions about how to operate the fixture safely, please contact your Martin™ supplier or call the Martin™ 24-hour service hotline on +45 8740 0000, or in the USA on 1-888-tech-180.



PROTECTION FROM ELECTRIC SHOCK

- Do not remove any cover from the fixture's base or yoke.
- Disconnect the fixture from AC power before removing or installing any cover or part – including the lamp – from the head and when not in use.
- Ensure that the fixture is electrically connected to ground (earth).
- Use only a source of AC power that complies with local building and electrical codes and has both overload and ground-fault (earth-fault) protection.
- The power input cable must be rated 20 A, hard usage type and heat-resistant to 90° C (194° F) minimum. It must have three conductors and an outer cable diameter of 5 - 15 mm (0.2 - 0.6 in.). In North

America the cable must be 12 AWG minimum conductor size, SJT or better. In the EU the cable must be 2.5 mm², HAR compliant.

- Before using the fixture, check that all power distribution equipment and cables are in perfect condition and rated for the current requirements of all connected devices.
- Isolate the fixture from power immediately if the power cable or power plug are in any way damaged, defective or wet, or if they show signs of overheating.
- Do not expose the fixture to rain or moisture.



LAMP SAFETY

- Prolonged exposure to an unshielded discharge lamp can cause eye and skin burns. Do not stare directly into the light output. Never look at an exposed lamp while it is lit. Do not operate the fixture with missing or damaged covers, shields, lenses or ultraviolet screens.
- A hot discharge lamp is under pressure and can explode without warning. Allow the fixture to cool for at least 30 minutes and protect yourself with safety glasses and gloves before handling a lamp or servicing the fixture internals.
- Replace the lamp immediately if it becomes visually deformed, damaged or in any way defective
- Monitor hours of lamp use and lamp intensity and replace the lamp when it reaches the limit of its service life as specified in this product's specifications or by the lamp manufacturer.
- Install only a lamp that is specifically approved by Martin™ for this product.
- If the quartz envelope of a discharge lamp is broken, the lamp releases a small quantity of mercury and other toxic gases. If a discharge lamp explodes in a confined area, evacuate the area and ventilate it thoroughly. Wear nitrite gloves when handling a broken discharge lamp. Treat broken or used discharge lamps as hazardous waste and send to a specialist for disposal.



PROTECTION FROM BURNS AND FIRE

- The exterior of the fixture becomes very hot – up to 150° C (302° F) – during use. Avoid contact by persons and materials. Allow the fixture to cool for at least 30 minutes before handling.
- Keep all combustible materials (e.g. fabric, wood, paper) at least 0.3 m (12 in.) away from the fixture. Keep flammable materials well away from the fixture.
- Provide a minimum clearance of 0.1 m (4 in.) around fans and air vents.
- Do not illuminate surfaces within 1.6 m (5.2 ft.) of the fixture.
- Position or shade the head so that the lens cannot face the sun – even for a few seconds – during daylight hours. The lens can focus the sun's rays inside the fixture, creating a potential fire hazard.
- Do not operate the fixture if the ambient temperature (Ta) exceeds 40° C (104° F).
- Do not modify the fixture in any way not described in this manual or the product's User Guide or install other than genuine Martin™ parts. Do not stick filters, masks or other materials onto any lens or other optical component. Use only accessories approved by Martin™ to mask or modify the light beam.



PROTECTION FROM INJURY

- Do not lift or carry the fixture alone.
- The handles in the base and on the top of the yoke are for use when carrying the product only. Do not use them for hoisting, primary attachment or secondary attachment.
- Use two evenly spaced clamps to suspend the fixture from rigging structures. Do not use only one clamp.
- When clamping the fixture to a truss or other supporting structure at any other angle than with the yoke hanging vertically downwards, use two half-coupler clamps. Do not use G-clamps, quick-trigger clamps or any other type of clamp that does not completely encircle the supporting structure when fastened.
- When suspending the fixture, ensure that the supporting structure and all hardware used can hold at least 10 times the weight of all devices suspended from them.
- Install as described in this manual a secondary attachment such as a safety cable that is approved by an official body such as TÜV as a safety attachment for the weight of all the fixtures it secures. The safety cable must comply with EN 60598-2-17 Section 17.6.6 and also be capable of bearing a static suspended load ten times the weight of the fixture.
- Check that all external covers and rigging hardware are securely fastened.
- Block access below the work area and work from a stable platform whenever installing, servicing or moving the fixture.

Introduction

Thank you for selecting the Martin™ MAC Viper Profile™. This moving-head spotlight features:

- 1000 Watt short-arc Osram HTI 1000/PS Lok-it discharge lamp
- Full-spectrum CMY color mixing and color temperature control
- Color wheel with 8 interchangeable dichroic color filters
- Aerial and breakup gobo wheels, each with 5 interchangeable rotating gobos with 16-bit position indexing
- FX wheel with gobo animation and static gobo ranges
- Interchangeable four-facet rotating prism
- Soft frost filter
- Iris
- Full-range mechanical dimmer with four dimming curve options, plus mechanical shutter
- Variable focus and zoom with 3-zone zoom/focus linking system
- Backlit graphic display and battery power (mains power not required for fixture setup)
- Electronic “flicker-free” ballast and auto-sensing switch-mode power supply.

For the latest firmware updates, documentation, and other information about this and all Martin Professional products, please visit the Martin website at <http://www.martin.com>

Comments or suggestions regarding this document may be e-mailed to service@martin.dk or posted to: Technical Documentation, Martin Professional A/S, Olof Palmes Allé 18, DK-8200 Aarhus N, Denmark.

Unpacking

The MAC Viper Profile is packaged in either a cardboard box or a flightcase that is designed to protect the product during shipment. The following items are included:

- Osram HTI 1000/PS Lok-it discharge lamp (installed)
- 2 omega brackets for clamp attachment
- This Safety and Installation Manual

The MAC Viper Profile User Guide, containing full details of setting up, controlling and monitoring the fixture, is available for download from the MAC Viper Profile Product Support page on the Martin website at www.martin.com. If you have any difficulty locating this document, please contact your Martin supplier for assistance.

Tilt lock

Release the tilt lock before applying power to the fixture.

Release the tilt lock before packing the fixture in its Martin™ flightcase.

See Figure 1. Release the tilt lock by pushing the lock in towards the yoke (you can reapply the tilt lock by first checking that the power is off and then pushing the lock back in towards the yoke from the other side).

There is no pan lock on the MAC Viper Profile.

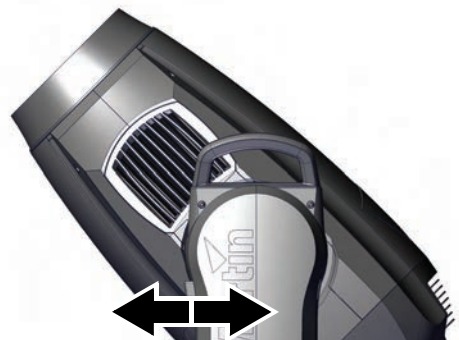

Figure 1: Tilt lock

Packing

Important! Release the tilt lock and allow the fixture to cool before packing it in its flightcase.

The anti-shock material in the MAC Viper Profile flightcase is designed to protect the head without the tilt lock applied. Release the tilt lock when transporting the fixture in the flightcase. Leaving the tilt lock applied may cause damage that is not covered by the product warranty.

Physical installation



Warning! The MAC Viper Profile has a powerful pan motor. The torque reaction when the head is panned suddenly can cause the base to move if the fixture is standing unsecured on a surface. Do not apply power to the MAC Viper Profile unless the base is securely fastened to a surface or to rigging hardware.

Warning! Use 2 clamps to rig the fixture. Do not hang the fixture from only one clamp. Lock each clamp with both 1/4-turn fasteners. Fasteners are locked only when turned fully clockwise.

Warning! When suspending the fixture above ground level, secure it against failure of primary attachments by attaching a safety wire that is approved as a safety attachment for the weight of the fixture to the attachment point in the base. Do not use the carrying handles for secondary attachment.

Warning! When clamping the fixture to a truss or other structure at any other angle than with the yoke hanging vertically downwards, use two clamps of half-coupler type. Do not use any type of clamp that does not completely encircle the structure when fastened.



Warning! Position or shade the head so that the lens does not face the sun at any time – even for a few seconds – during daylight hours. The MAC Viper Profile's lens can focus the sun's rays inside the fixture, creating a potential fire hazard and causing internal damage.

Important! Do not point the output from other lighting fixtures at the MAC Viper Profile from a distance of less than 3 m (10 ft.), as intense illumination can damage the display.

The MAC Viper Profile can be fastened to a surface such as a stage or clamped to a truss in any orientation. Clamps must be half-coupler type (see Figure 3) unless the fixture is installed with the yoke hanging vertically downwards, in which case other clamp types that are approved for the supported weight may be used.

The mounting points allow the clamp brackets to be fastened parallel, perpendicular or at 45° to the front, as shown in Figure 2.

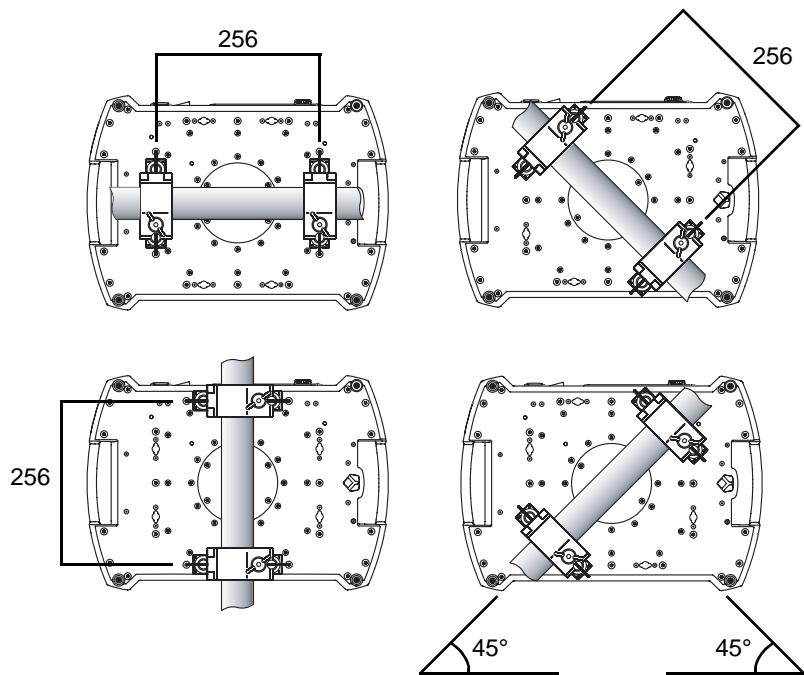
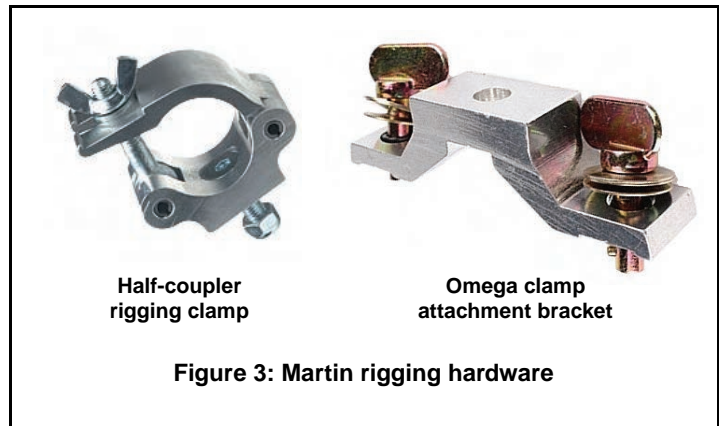

Figure 2: Clamp bracket positions

Clamping the fixture on a truss

1. Check that the rigging clamps are undamaged and can bear at least 10 times the weight of the fixture. Check that the structure can bear at least 10 times the weight of all installed fixtures, clamps, cables, auxiliary equipment, etc.
2. Bolt each clamp securely to a clamp attachment bracket with an M12 bolt (minimum grade 8.8) and lock nut.



3. See Figure 4. Note the position of the arrow on the bottom of the base that indicates the front of the fixture.

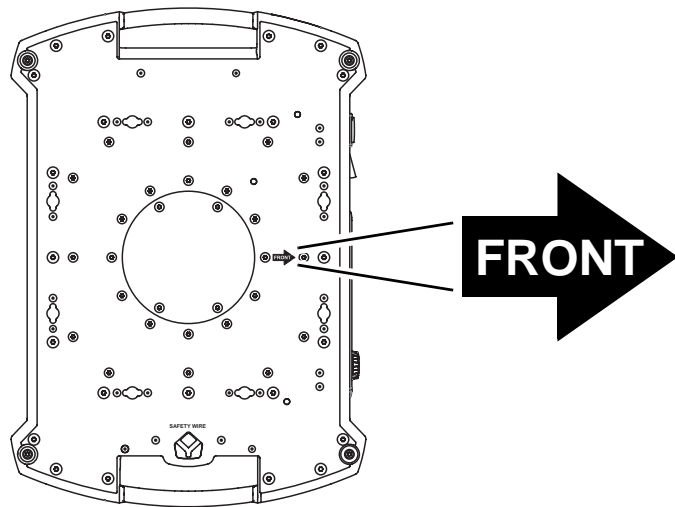

Figure 4: Front of fixture

4. Align the first clamp and bracket with 2 mounting points in the base. See Figure 5. Insert the clamp bracket's fasteners into the base and turn both levers a full 1/4-turn clockwise to lock. Repeat for the second clamp.
5. Block access under the work area. Working from a stable platform, hang the fixture on the truss with the arrow marked **FRONT** printed on the base of the fixture facing towards the area to be illuminated. Tighten the rigging clamps.

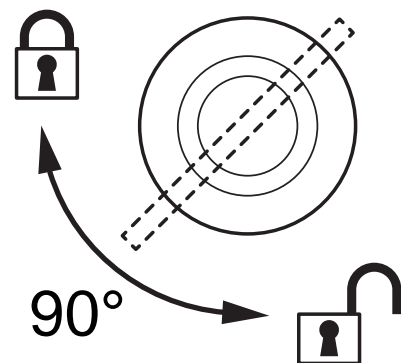

Figure 5: Locking 1/4-turn fasteners

6. See Figure 6. Install a safety wire that is approved as a safety attachment for the weight of the fixture by looping it through the safety attachment point (arrowed) on the bottom of the base and around a secure anchoring point so that the safety attachment will catch the fixture if the primary attachment fails.
7. Check that the tilt lock is released. Check that there are no combustible materials within 0.3 m (12 in.) or surfaces to be illuminated within 1.6 m (5.2 ft.) of the fixture, and that there are no flammable materials nearby.
8. Check that there is no possibility of heads or yokes colliding with other fixtures.
9. Check that other lighting fixtures cannot project light at the MAC Viper Profile from a distance of less than 3 m (10 ft.), as intense illumination can damage the MAC Viper Profile's display.

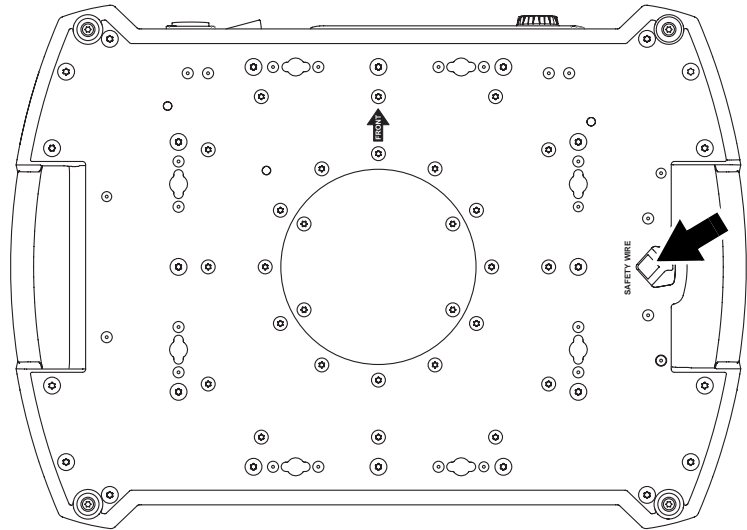

Figure 6: Safety cable attachment point

AC power



Warning! For protection from electric shock, the fixture must be electrically connected to ground (earth). The AC mains power supply must be fitted with a fuse or circuit breaker and ground-fault (earth-fault) protection.



The MAC Viper Profile features an auto-sensing switch-mode power supply that automatically adapts to AC power at 120-240 V (nominal), 50/60 Hz.



Power input

Important! Connect the MAC Viper Profile directly to AC power. Do not connect it to a dimmer system; doing so may damage the fixture.

The MAC Viper Profile requires a power input cable with a Neutrik PowerCon NAC3FCA cable connector for AC mains power input. The cable must meet the requirements listed under “Protection from electric shock” on page 4.

Martin™ can supply either a suitable 3 m (9.8 ft.) power cable with PowerCon input connector installed or the PowerCon input connector without a cable (see “Accessories” on page 31).

Installing a power input connector on a power cable

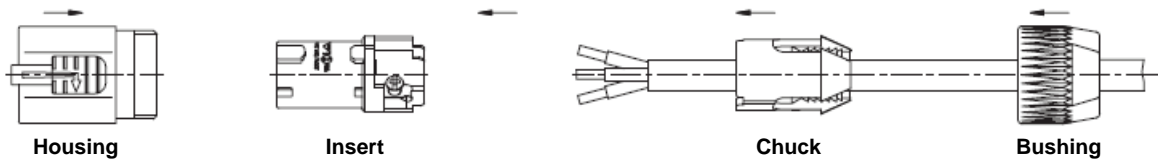

To install a Neutrik PowerCon NAC3FCA input connector on a power cable, see illustrations above and right:

1. Slide the bushing over the cable.
2. Slide the white chuck over cables with a diameter (D_a) of 5 - 10 mm (0.2 - 0.4 in.), or the black chuck over cables with a diameter of 10 - 15 mm (0.4 - 0.6 in.).
3. Prepare the end of the cable by stripping 20 mm (0.8 in.) of the cable's outer jacket.
4. Strip 8 mm (1/3 in.) of insulation from the end of each wire.
5. Use a small flathead screwdriver to fasten the wires into the connector terminals in the insert as follows:
 - live wire into the terminal marked **L**
 - neutral wire into the terminal marked **N**
 - ground (earth) wire into terminal marked \perp .
6. Push the insert and chuck into the housing (note the raised key and keyway to ensure correct orientation).
7. Fasten the bushing to the housing using a wrench to a torque of 2.5 Nm (1.8 lb.-ft).

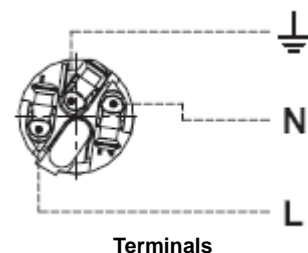
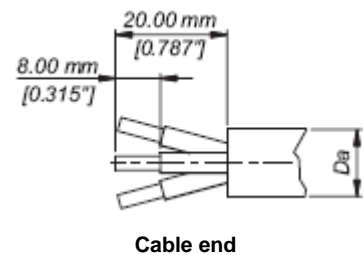

Illustrations used by kind permission of Neutrik AG

Connecting to an AC mains power source

The MAC Viper Profile power cable can be hard-wired to a building installation circuit or fitted with a cord cap (mains plug) to allow connection to local AC mains power outlets. If you install a cord cap (mains plug), install a grounding-type (earthed) plug, following the plug manufacturer's instructions. Table 1 shows some possible mains power pin identification schemes; if the pins are not clearly identified, or if you have any doubts about proper installation, consult a qualified electrician.

Wire Color	Pin	Symbol	Screw (US)
brown	live	L	yellow or brass
blue	neutral	N	silver
yellow/green	ground (earth)		green

Table 1: Cord cap connections

Applying power

See Figure 7. To apply power to the MAC Viper Profile, check that the tilt lock is released, that the base is held securely, and that personal safety will not be put at risk when the lamp strikes and the fixture moves, then set the power on/off switch **B** to **I** (On).

Check that the mains power on/off switch **B** is set to **O** (Off) before inserting or removing the power input connector at the input socket **A**, otherwise you may cause arcing at connector terminals that can damage them.

Shutting down power

For optimum lamp life, wait at least 5 minutes after striking a discharge lamp before dousing the lamp.

It is also good practise to douse the lamp a few minutes before shutting down power. This gives the fans time to cool the fixture down.

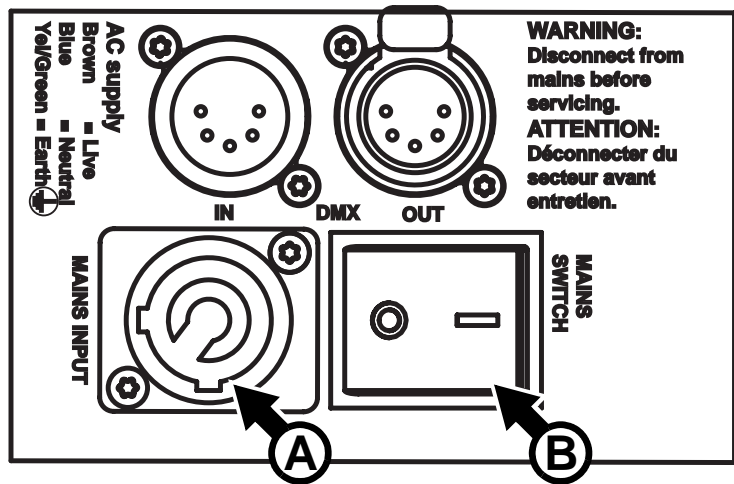

Figure 7: Mains input socket and mains power on/off switch

DMX data link

The MAC Viper Profile has 5-pin locking XLR sockets for DMX and RDM input and output (see Figure 7 on page 12). The default pin-out on both sockets is:

- pin 1 to shield
- pin 2 to data 1 cold (-)
- pin 3 to data 1 hot (+).

Tips for reliable data transmission

- Use shielded twisted-pair cable designed for RS-485 devices: standard microphone cable cannot transmit control data reliably over long runs. 24 AWG cable is suitable for runs up to 300 meters (1000 ft). Heavier gauge cable and/or an amplifier is recommended for longer runs.
- To split the data link into branches, use one of the splitter-amplifiers available from Martin (see under “Accessories” in the product specifications given at the end of this document.)
- Do not overload the link. Up to 32 devices may be connected on a serial link.
- Install a DMX termination plug on the last fixture on the link.

Connecting the data link

1. Connect the DMX data output from the controller to the MAC Viper Profile's data input (male XLR) socket.
2. Run the data link from the MAC Viper Profile's data output (female XLR) socket to the data input of the next fixture.
3. Terminate the data link by connecting a 120 Ohm, 0.25 Watt resistor between the data 1 hot (+) and cold (-) conductors (and between data 2 hot and cold if used) at the data output of the last fixture on the link. If a splitter is used, terminate each branch of the link.

Service and maintenance



Warning! Read “Safety Information” on page 4 before servicing the MAC Viper Profile.

Warning! Disconnect the fixture from AC mains power and allow to cool for at least 30 minutes before handling. Do not stare into the light output. Be prepared for the fixture to light and move suddenly when connected to power.



Warning! The MAC Viper Profile™ contains components that are accessible and live at high voltage while the fixture is connected to power and that remain under tension for 30 minutes after power is disconnected. Only technicians who are authorized by Martin™ and who have access to the Martin™ service documentation for the MAC Viper Profile are permitted to open the base and yoke of the fixture. The user may open the MAC Viper Profile’s head only to carry out the service operations described in this section, following the warnings and instructions provided. Refer any service operation not described in this manual or the product’s User Guide to a qualified service technician.



Important! Excessive dust, smoke fluid, and particle buildup degrades performance, causes overheating and will damage the fixture. Damage caused by inadequate cleaning or maintenance is not covered by the product warranty.

The user will need to clean the MAC Viper Profile periodically. The user may also replace gobos, color filters, the iris, the FX wheel and air filters in the head and update the firmware. All other service operations on the MAC Viper Profile must be carried out by Martin Professional™, its approved service agents or trained and qualified personnel using the official Martin™ service documentation for the MAC Viper Profile.

Installation, on-site service and maintenance can be provided worldwide by the Martin Professional Global Service organization and its approved agents, giving owners access to Martin’s expertise and product knowledge in a partnership that will ensure the highest level of performance throughout the product’s lifetime. Please contact your Martin supplier for details.

It is Martin policy to apply the strictest possible calibration procedures and use the best quality materials available to ensure optimum performance and the longest possible component lifetimes. However, optical components are subject to wear and tear over the life of the product, resulting in gradual changes in color over many thousands of hours of use. The extent of wear and tear depends heavily on operating conditions and environment, so it is impossible to specify precisely whether and to what extent performance will be affected. However, you may eventually need to replace optical components if their characteristics are affected by wear and tear after an extended period of use and if you require fixtures to perform within very precise optical and color parameters.

Tilt lock

The tilt position of the head can be locked at 45° for service. See Figure 1 on page 6. Push the lock in towards the yoke in one direction to lock the head and back in from the other side to unlock the head.

Important! Release the tilt lock before applying power to the fixture and before packing the fixture in its flightcase.

Lamp

The MAC Viper Profile is designed for use with a highly efficient 1000 watt short-arc Osram HTI 1000/PS Lok-it discharge lamp. This lamp has a color temperature of 6000 K, a color rendering index greater than 85 and an average service life of 750 hours. Do not use any lamp that is not approved by Martin™ for the MAC Viper Profile.

Warning! Installing a lamp that is not approved may create a safety hazard or damage the fixture!

Lamp power is automatically reduced to approximately 800 W after 10 seconds when the dimmer/shutter is closed in order to reduce cooling fan activity and power consumption. The lamp returns to 1000 W as soon as the dimmer/shutter is opened.

Lamp life

Monitor lamp hours using the resettable **LAMP ON TIME** counter in the **INFORMATION** control menu. To reduce the risk of explosion, replace the lamp when it reaches the limit of its average service life, i.e. when usage reaches 750 hours. Never exceed the lamp's average service life by more than 10%. Replace the lamp immediately if it is deformed or in any way defective.

For maximum service life:

- Avoid powering the lamp off until it has warmed up for at least 5 minutes.
- Before shutting down power completely, douse the lamp but leave power applied for a few minutes so that cooling fans can prevent any momentary lamp temperature increase caused by heat from surrounding components.

Lamp replacement



Warning! Wear safety glasses and gloves when handling lamps. The clear lamp bulb is integral with the ceramic lamp base. Do not try to separate the bulb from the base.

Important! The lamp can be a stiff fit in its holder. Twist the lamp base a full 45° clockwise when installing to ensure that the lamp contacts are fully engaged.

Replacement lamps are available from Martin™ by ordering P/N 97010346.

The clear bulb must be perfectly clean. Do not touch it with your fingers. Clean the lamp with an alcohol wipe and polish it with a clean, dry lint-free cloth before installing, particularly if you accidentally touch the bulb.

To replace the lamp:

1. Douse the lamp but leave power applied for at least 30 minutes so that cooling fans continue to run, then disconnect the fixture from power.
2. Tilt the head so that the text around the lamp access cover is facing the right way up and the cover is easy to reach.
3. See Figure 8. Release the Torx 20 cover screw **A** and open the cover.
4. See Figure 9. Grasp the ceramic lamp base, twist it 45° counterclockwise to release it, then remove the lamp gently from the fixture.
5. See Figure 10. Hold the replacement lamp so that the external wire **B** is facing up towards the top of the head (towards the vertical and horizontal alignment screws **C** and **D**) and line up the contacts on the lamp base with the slots in the lampholder. Slide the lamp into the fixture until the contacts are fully inserted in the slots, then twist the lamp base a full 45° clockwise until it locks into position with a noticeable click. The lamp is a stiff fit and trying to strike a lamp that is not correctly installed can cause damage that is not covered by the product warranty, so ensure that the lamp is correctly locked into position.

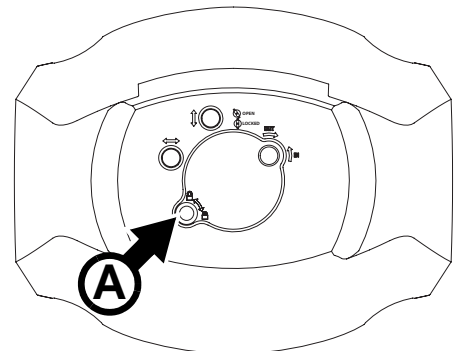

Figure 8: Lamp access

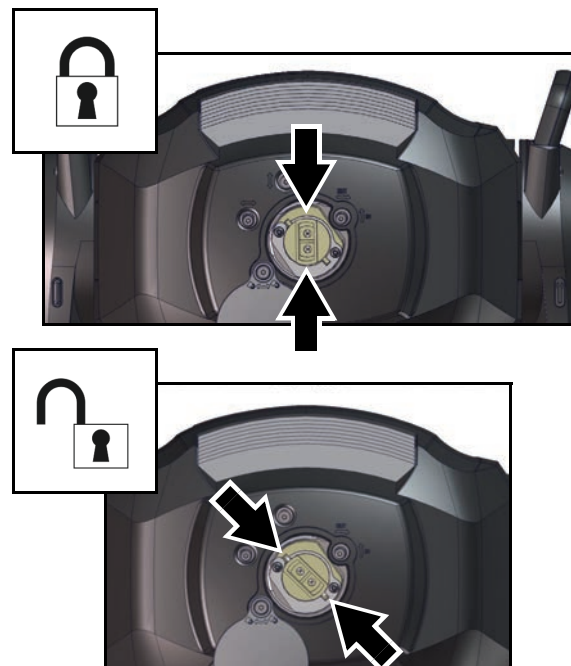

Figure 9: Lamp lock / unlock

- Close the lamp access cover and tighten the screw to secure the cover before reapplying power.

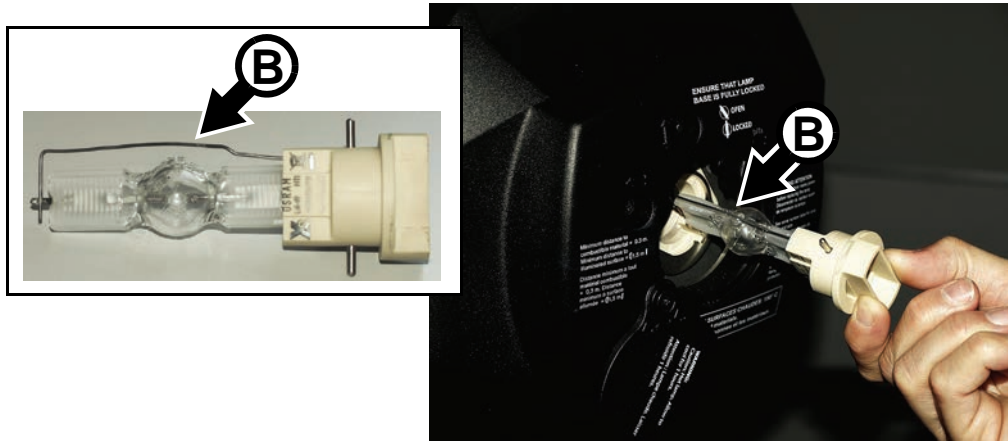

Figure 10: Lamp removal / refitting

- After installing a new lamp, reset the **LAMP ON TIME** counter in the control menu.

Lamp adjustment



Warning! Adjust the lamp with the fixture cool. The fixture may become hot during adjustment, so wear heat-resistant safety gloves.

As well as giving uneven projection, a significant hot-spot in the beam will focus extra heat onto optical components and may cause damage that is not covered by the product warranty.

After fitting a new lamp, adjustment may be required to obtain an even beam.

To adjust the lamp:

- If the fixture has been in use, douse the lamp but leave power applied. Allow the fixture to cool for at least 30 minutes. If the fixture is powered off, apply power and allow the fixture to reset.
- Set zoom to wide so that it is easier to see any unevenness in the projection. Strike the lamp and open the shutter.
- Aim the fixture at an even surface and make sure that no further commands can be sent by DMX.
- See Figure 11. Turn the three Torx 20 lamp adjustment screws **C**, **D** and **E** to obtain the most even beam.

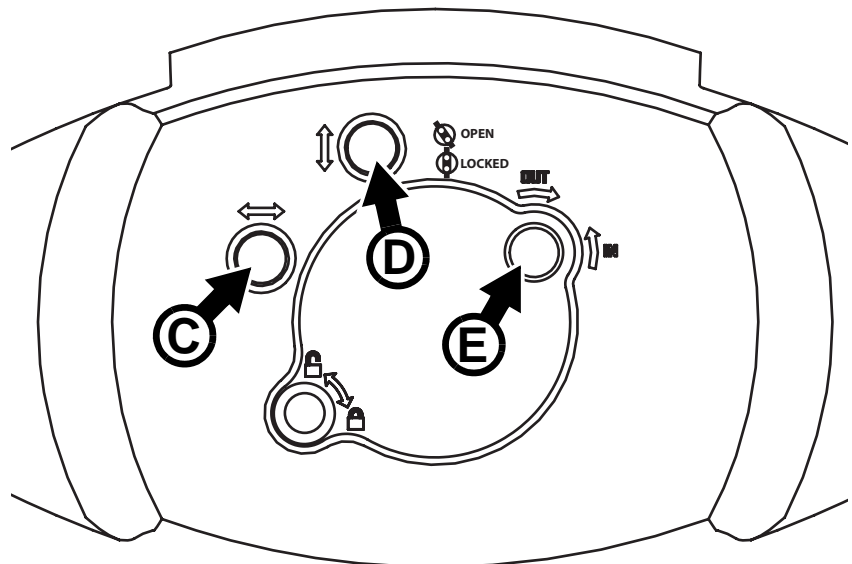

Figure 11: Lamp adjustment

Access to the head



Warning! Disconnect from power and allow to cool for 30 minutes before opening the head.



To open the head:

1. Disconnect the fixture from power, allow components to cool for 30 minutes and apply the tilt lock.
2. See Figure 12. Remove both head covers by loosening their Torx 25 captive retaining screws **A** until the screws turn freely. Lift the front of each cover slightly away from the head, then slide the cover towards the front of the head to release the rear of the cover.
3. You can allow head covers to hang on their safety wires, but for easiest access press each cover's safety wire retaining clip **B** in towards the head chassis, slide the clip until you can remove it, then remove the head cover completely from the fixture.

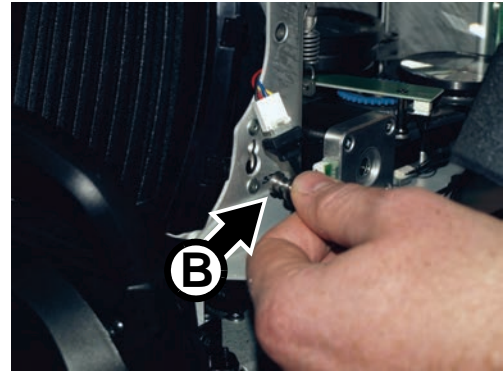

Figure 12: Access to the head

4. For easiest access to the components inside the head, position the head with the top facing upwards (in this position the text on the lamp cover is the right way up) at an angle with the front facing downwards, then apply the tilt lock.

To reinstall the head covers:

1. See Figure 12. Hold each cover up to the head and fasten its safety wire retaining clip **B** into the head chassis by pressing the clip through its hole and then sliding it until it is held securely.
2. Slide the rear of the cover towards the back of the head until its retaining clips locate, then swing the front of the cover in towards the head and fully tighten each cover's two Torx 25 retaining screws. Check that each cover is securely attached.
3. Release the tilt lock before applying power or packing the MAC Viper Profile in its flightcase.



Figure 13: Head positioned for service access

Cleaning

Regular cleaning is very important for fixture life and performance. Buildup of dust, dirt, smoke particles, fog fluid residues, etc. degrades the fixture's light output and cooling ability.

Cleaning schedules for lighting fixtures vary greatly depending on the operating environment. It is therefore impossible to specify precise cleaning intervals for the MAC Viper Profile. Cooling fans suck in airborne dust and smoke particles, and in extreme cases fixtures may require cleaning after surprisingly few hours of operation. Environmental factors that may result in a need for frequent cleaning include:

- Use of smoke or fog machines.
- High airflow rates (near air conditioning vents, for example).
- Presence of cigarette smoke.

- Airborne dust (from stage effects, building structures and fittings or the natural environment at outdoor events, for example).

If one or more of these factors is present, inspect fixtures within their first few hours of operation to see whether cleaning is necessary. Check again at frequent intervals. This procedure will allow you to assess cleaning requirements in your particular situation. If in doubt, consult your Martin dealer about a suitable maintenance schedule.

Work in a clean, well lit area. Use gentle pressure only when cleaning. Do not use any product that contains abrasives. Do not use solvents on plastic or painted surfaces. Use care when cleaning optical components: the coated surfaces are fragile and easily scratched.

To clean the head:

1. Disconnect the fixture from power and allow it to cool for 30 minutes.
2. Remove the head covers (see "Access to the head" on page 17).
3. Vacuum or gently blow away dust and loose particles inside the head with compressed air.
4. Carefully clean the optical components, but note that special precautions apply to the gobos (see "Gobo handling and storage" on page 22). Remove smoke and other residues with cotton swabs or unscented lens tissues moistened with isopropyl alcohol. A commercial glass cleaner may be used, but residues must be removed with distilled water. Clean with a slow circular motion from center to edge. Dry with a clean, soft, lint-free cloth or low-pressure compressed air. Remove stuck particles with an unscented tissue or cotton swab moistened with glass cleaner or distilled water. Do not rub the surface: lift the particles off with a soft repeated press.
5. Remove dust from fans and air vents with a soft brush, cotton swab, vacuum, or compressed air.
6. If you have finished work on the head, reinstall the head covers as described in "Access to the head" on page 17 and release the tilt lock before reapplying power.

Replacing the head air filters

There are two disposable air filters in the MAC Viper Profile head. They must be replaced as a pair when they become dirty.

The replacement procedure is the same for each air filter:

1. Disconnect the fixture from power and allow it to cool for 30 minutes.
2. Remove the head covers (see "Access to the head" on page 17).
3. See Figure 14. Loosen the two captive Torx 25 screws **A** at the front end of the filter housing until the screws turn freely.
4. Disconnect the air filter fan connector **B**.
5. Slide the filter housing towards the front of the fixture to release the rear of the housing, then lift the housing away from the head.
6. Press down on the two clips **C** until they release and you can open the filter housing.

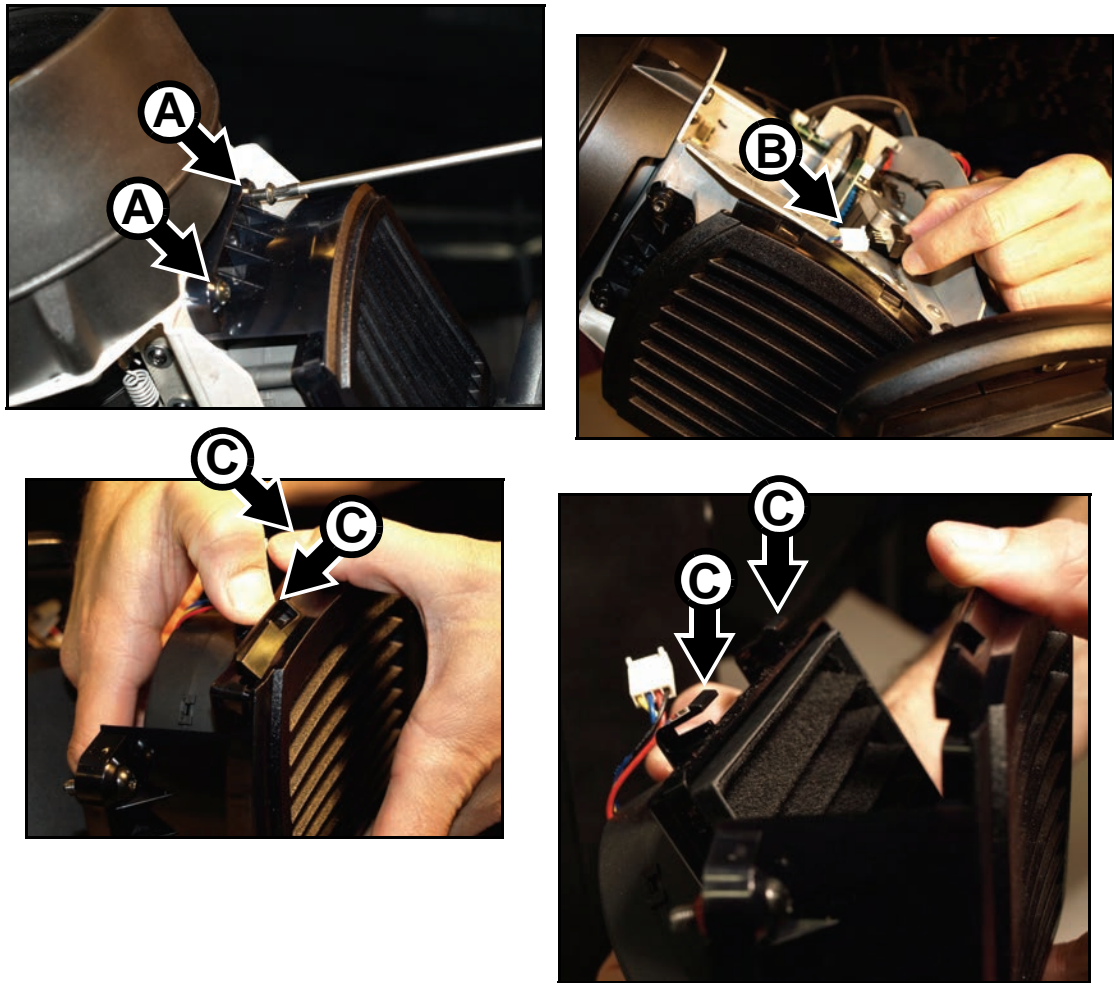

Figure 14: Head air filter removal

7. Remove the old air filter element from the filter housing and put the new element into position with the ribs in the element running from top to bottom (in the same direction as the louvers in the filter housing cover) as shown in Figure 15.
8. See Figure 14. Hook the side of the cover opposite the clips **C** into the housing and then press the cover onto the housing, checking that the clips snap into the housing and that the cover is located correctly with no gaps where air could bypass the filter.
9. Reconnect the air filter fan connector **B**.
10. Hook the rear end of the air filter housing into position in the head by sliding it towards the rear of the fixture. Then hold the front of the housing in position against the front of the head while you fasten the two Torx 25 screws **A**.
11. If you have finished work on the head, reinstall the head covers as described in “Access to the head” on page 17 and release the tilt lock before reapplying power.



Figure 15: Head air filter alignment

Lubrication

The MAC Viper Profile does not require lubrication under normal circumstances. The slides for the zoom and focus lens cars are lubricated with a long-lasting teflon-based grease that can be reapplied by a Martin service partner if necessary.

Replacing optical components

Optical components have fragile coatings and are exposed to very high temperatures. Use only genuine Martin™ parts. Handle and store components with care. Wear cotton gloves while handling them and keep them perfectly clean to reduce the risk of heat damage.

Replacing the prism

The MAC Viper Profile is supplied with a four-facet rotating prism as standard.

To replace the prism:

1. Disconnect the fixture from power and allow it to cool for 30 minutes.
2. Remove the head covers, position the head with the front glass angled downwards and the top side facing upwards, and apply the tilt lock (see “Access to the head” on page 17).
3. See Figure 16. Slide the zoom/focus car **A** to its forward limit.
4. Holding the prismholder **B** by its teeth, pull it out of its clip **C**.

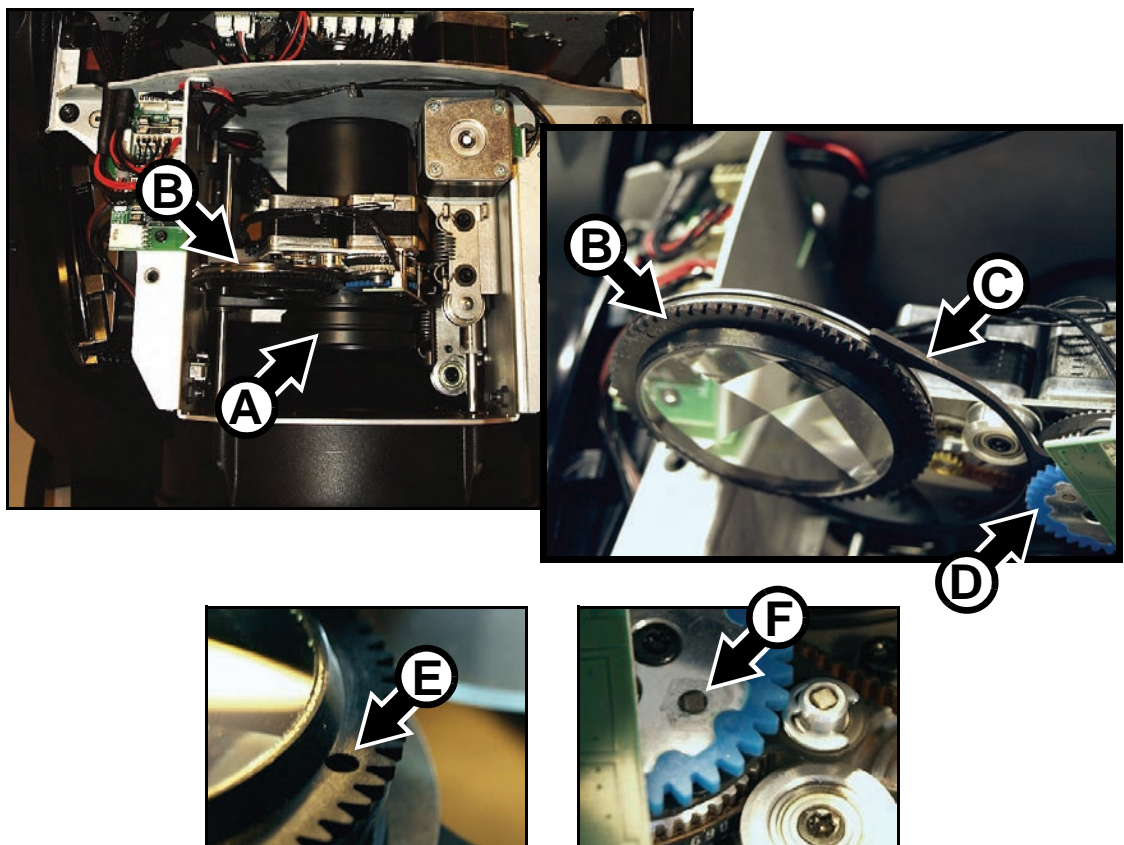

Figure 16: Prism removal and installation

5. When installing a prism, note that the prismholder **B** is marked with a hole **E**, and the blue prism actuation cog **D** has a magnet **F** embedded in it. Slide the prismholder **B** into its clip **C** so that the hole **E** lines up with the magnet **F** when the teeth in the prismholder and actuation cog mesh with each other.
6. Check that the prismholder is held securely.
7. If no further service work is to be carried out, reinstall the head covers as described in “Access to the head” on page 17 and release the tilt lock before reapplying power.

Gobos: general

The MAC Viper Profile uses specially designed borosilicate 3.3 gobos with a heavy matted aluminum coating that require particularly careful handling and storage. The MAC Viper Profile User Guide available for download from www.martin.com gives names, illustrations and part numbers of the gobos installed as standard.

The use of metal gobos in the MAC Viper Profile is not recommended.

Do not use gobos with dark coatings on any side, as these will absorb heat – either directly from the lamp or reflected back from other gobos and optical components – and will not be durable.

Gobo orientation

The orientations shown in Figure 17 are correct in most cases, but consult your Martin dealer or gobo supplier if you are in any doubt about the orientation of a specific gobo type.

Coated Glass Gobos

The heavy matted aluminum coated borosilicate gobos in the MAC Viper Profile are factory-installed with the more reflective sides facing towards the lamp. Replacement gobos must also be installed with more reflective sides facing the lamp in order to avoid heat damage.

More reflective side towards lamp

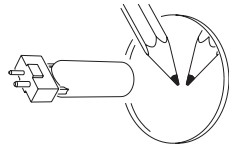

To minimize the risk of gobo overheating and damage, turn the more reflective side of a coated gobo towards the lamp.

Less reflective side away from lamp

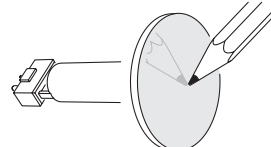

The less reflective side of a coated gobo will absorb less heat if it faces away from the lamp.

Textured Glass Gobos

Textured side towards lamp

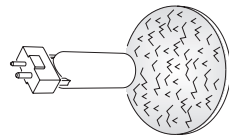

Smooth side away from lamp

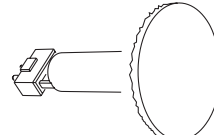

Textured glass gobos in the MAC Viper Profile sit most squarely in the gobo wheel with the textured side towards the lamp. If in doubt, consult your Martin dealer or gobo supplier.

Image / text Gobos

True image towards lamp

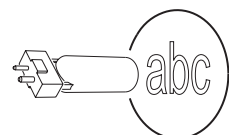

Reversed image away from lamp

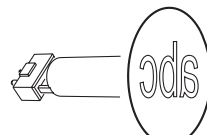

Figure 17. Correct gobo orientation

Gobo handling and storage

1. Store all gobos in a dust-free environment with approx. 50% humidity.
2. Always use clean gloves when handling gobos.
3. Avoid touching the other gobos when taking out a gobo from a rack: the sharp edge of one gobo can scratch the others.
4. Clean the coated side of gobos with dust and oil-free compressed air only.
5. Clean the uncoated side of gobos with photographic quality lens-cleaner and optics cleaning tissues. Use a repeated dabbing action rather than a rubbing action.
6. Avoid scratching coated and uncoated sides.
7. Never place a gobo with the coated side face-down on any surface.
8. Mount the gobo with the matted coating facing towards the front of the fixture, away from the lamp.

Replacing rotating gobos

Important! *A gobo can fall out of its holder if its spring is inserted the wrong way round.*

Do not lubricate gobo bearings: excess grease can cause loss of step.

Correct gobo orientation is critical. Read the guidelines in Figure 17 carefully before installing a gobo.

The MAC Viper Profile has two rotating gobo wheels: one is supplied with rotating breakup gobos, and one with rotating air FX gobos. Gobos are interchangeable.

To replace a gobo:

1. Disconnect the fixture from power and allow it to cool for 30 minutes.
2. Remove the head covers, position the head with the front glass angled downwards and the top side facing upwards, and apply the tilt lock (see "Access to the head" on page 17).
3. Turn the relevant gobo wheel until the gobo you want to replace is accessible from the top of the fixture.

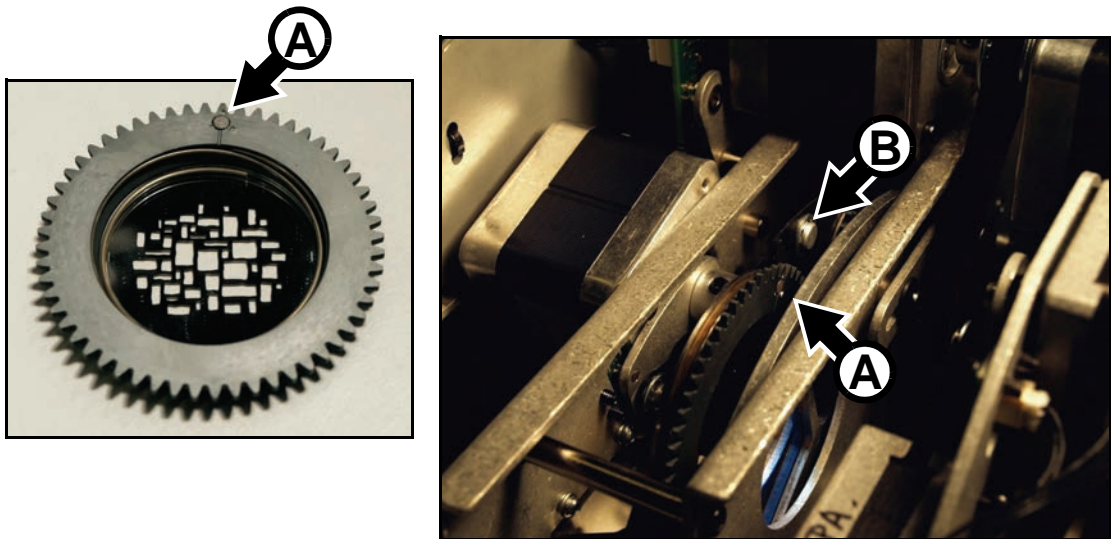

Figure 18: Goboholder position for replacement

4. See Figure 18. Rotate the goboholder until its magnet **A** lines up with a reference point that you choose on the module frame (**B** for example). Remove and insert any gobos you replace one by one, with the goboholder magnets lined up with your reference point, and avoid rotating the gobo wheel while a gobo is removed. This will keep gobos in the orientation they were designed for and avoid the need to reprogram the controller because a gobo orientation has changed during service.

5. See Figure 19. Grasp the goboholder by its teeth and pull it out of its clip to remove it from the wheel.
6. Note that the fused glass Limbo/Crystal gobo is glued into the goboholder and cannot be removed from it. If you need to replace this gobo, you must replace the entire goboholder. All the other gobos are held in their holders by springs and can be removed from the holders as described below.

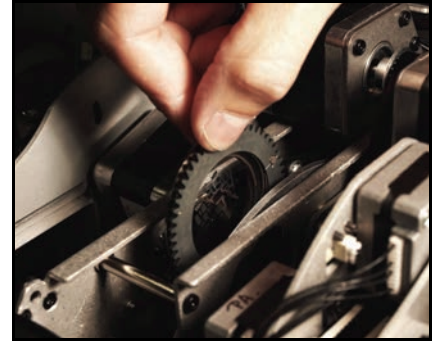

Figure 19: Gobo removal

7. See Figure 20, With a small screwdriver or similar, unhook the end of the gobo spring furthest from the gobo and pull out the spring. Drop the gobo out of the holder onto a clean, soft surface.
8. Insert the new gobo in the holder with the side that must face towards the lamp facing upwards, towards the spring (see Figure 20 and Figure 17).
9. Insert the spring with the narrow end against the gobo, as shown in Figure 20. To identify the narrow end, press the spring flat: the narrow end is on the inside. Push the wide end of the spring in under the lip of the holder.
10. Check that the gobo is seated flush against the holder. Press the spring as flat as possible against the back of the gobo.

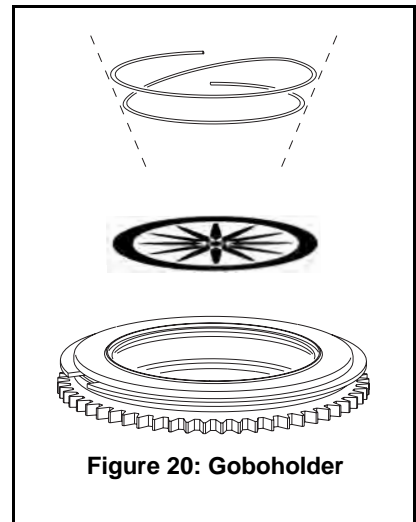

Figure 20: Goboholder

11. See Figure 21. Push the goboholder back into its clip so that the jaws **A** of the clip engage in the groove **B** around the goboholder and the magnet lines up with your reference point. Rotate the goboholder with a finger to check that it is correctly held in the clip and that the goboholder teeth mesh correctly in the teeth of the actuation cog in the center of the gobo wheel.
12. If necessary, continue replacing gobos one by one as described above.
13. If no further service work is to be carried out, reinstall the head covers as described in "Access to the head" on page 17 and release the tilt lock before reapplying power.

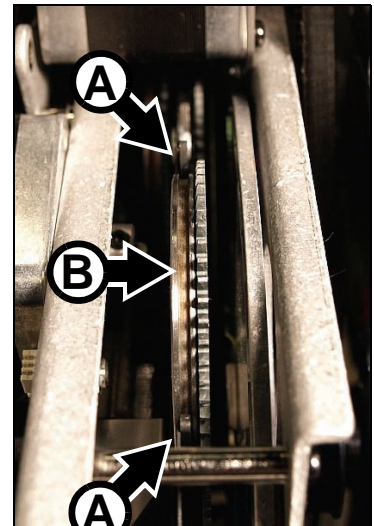

Figure 21: Gobo clip

Replacing a color filter

The MAC Viper Profile has eight dichroic color filters. See the MAC Viper Profile User Guide available for download from www.martin.com for names and part numbers.

Use only genuine Martin™ color filters. Handle and store filters with care. Wear cotton gloves while handling them and keep them perfectly clean.

To replace a color filter:

1. Disconnect the fixture from power and allow it to cool for 30 minutes.
2. Remove the head covers, position the head with the front glass angled downwards and the top side facing upwards, and apply the tilt lock (see “Access to the head” on page 17).
3. See Figure 22. Remove one of the gobos from the left-hand gobo wheel **A** as described in “Replacing rotating gobos” on page 22 (making sure that you line up the magnet with a reference point), so that you have access to both sides of the color wheel **B**.
4. Turn the color wheel **B** until the filter that you want to replace **C** is accessible. Put on clean cotton gloves and hold the filter near its outer edge between finger and thumb. Pull the outer edge of the filter away from the color wheel slightly to release it, then lift the filter carefully out of its clip and remove it. Store the filter resting on a clean, soft surface or in a filter rack.

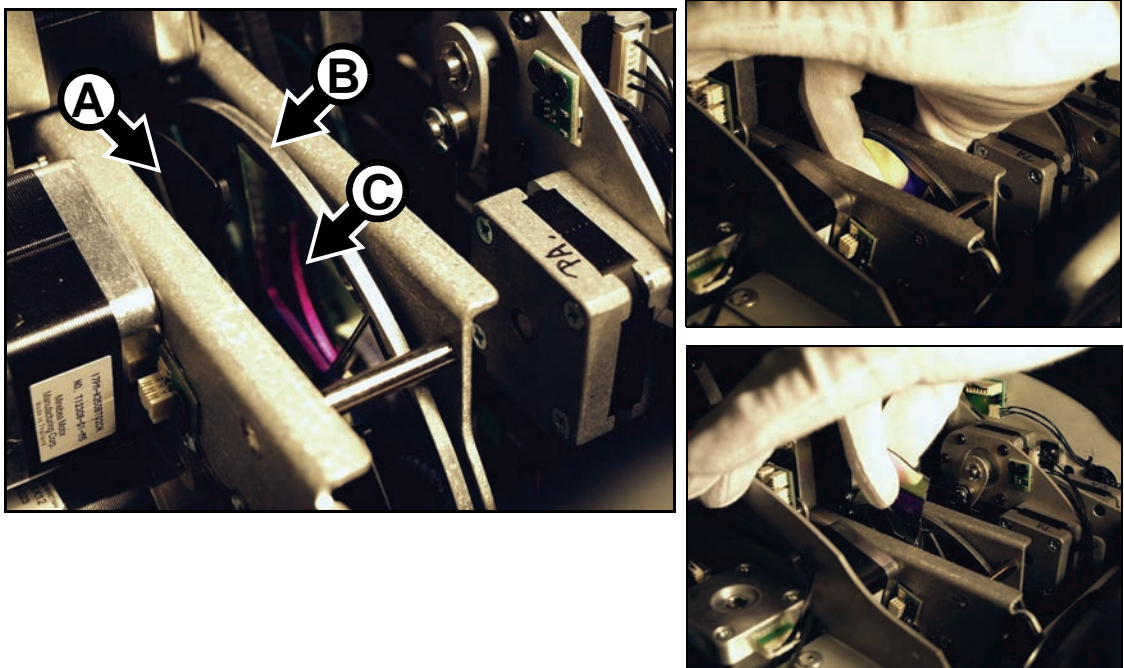

Figure 22: Color filter removal

5. To insert a color filter, put on cotton gloves and turn the filter so that its coated side will face towards the lamp. To find out which side of the filter is coated, hold an object up against the glass. There will be a gap between the object and its reflection on the non-coated side.
6. Slide the filter into its clip in the center of the color wheel. See Figure 23. Make sure that the outer edge of the filter locates under the lip (arrowed) on the edge of the color wheel so that the filter is held securely.
7. If necessary, continue replacing filters one by one as described above.
8. When you have finished replacing color filters, replace the goboholder that you removed as described in “Replacing rotating gobos” on page 22.
9. If no further service work is to be carried out, reinstall the head covers as described in “Access to the head” on page 17 and release the tilt lock before reapplying power.

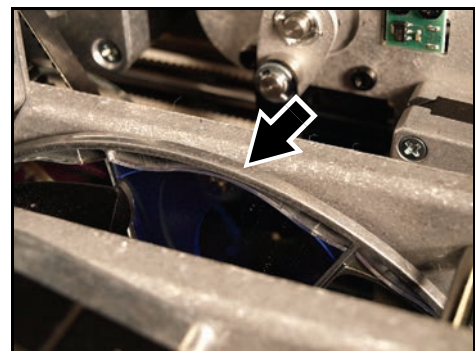

Figure 23: Color filter installation

Replacing the FX wheel

MAC Viper Profile has a motorized FX wheel that provides gobo animation effects and integrated gobos. See the MAC Viper Profile User Guide available for download from www.martin.com for full details.

To replace the FX wheel:

1. Disconnect the fixture from power and allow it to cool for 30 minutes.
2. Remove the head covers, position the head with the front glass angled downwards and the top side facing upwards, and apply the tilt lock (see "Access to the head" on page 17).
3. See Figure 24. Unhook the projection and color mixing module wiresets from their cutout **A** in the zoom/focus module chassis and unplug the two projection module connectors **B** and two color mixing module connectors **C** from their PCB **D**. Note that the PCB is marked with connector names.

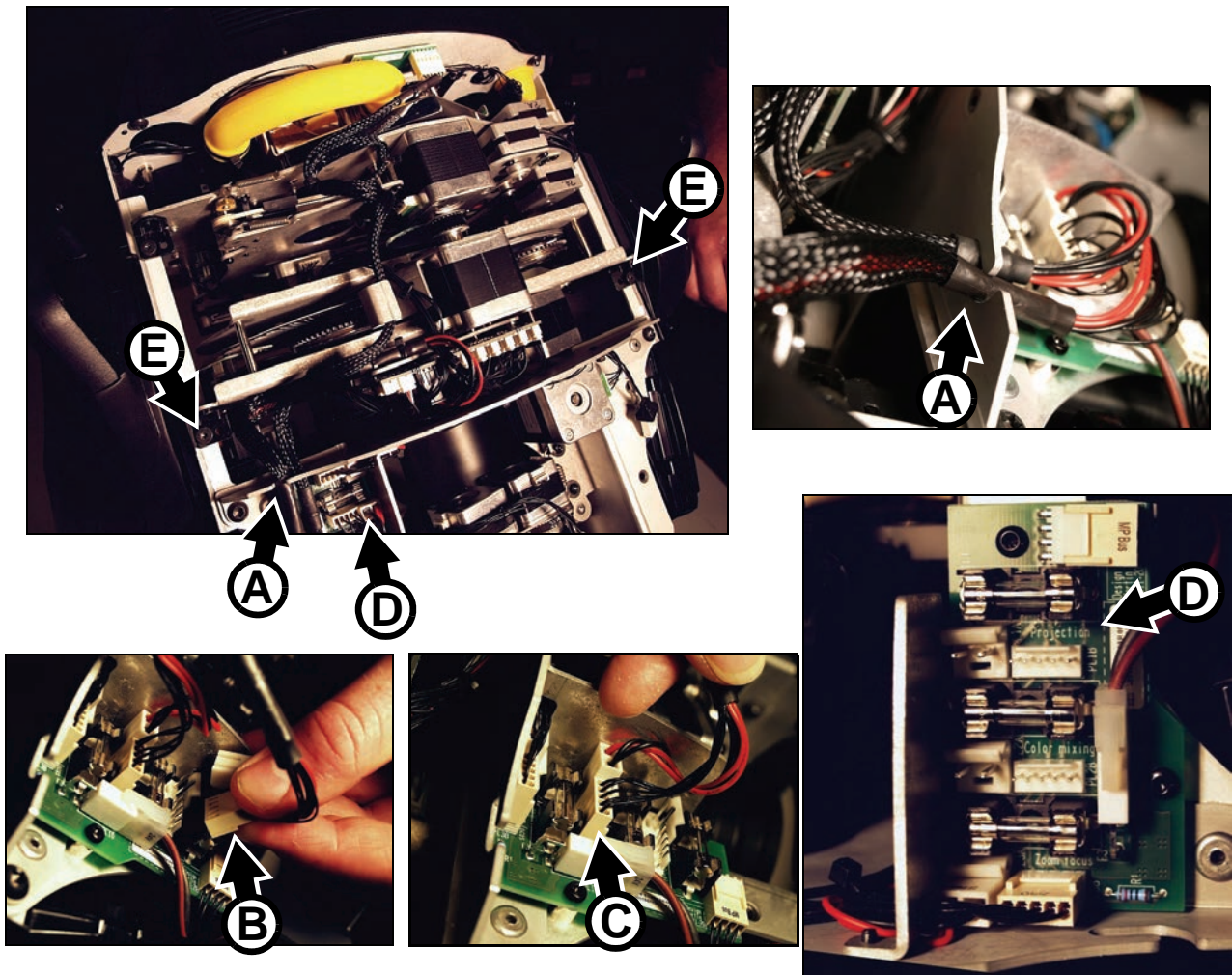

Figure 24: Projection module disconnection

4. Loosen the two Torx 20 screws **E** to release the projection module.
5. See Figure 25. Lift the projection module out of the head and place it with the motors facing down on a work surface.

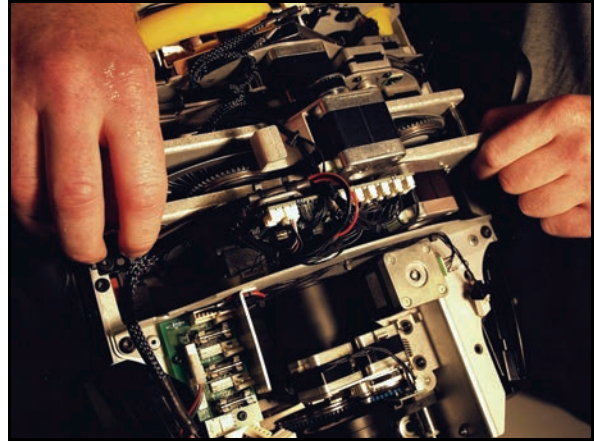

Figure 25: Projection module removal

6. See Figure 26. Remove the four Torx 10 screws (arrowed) that hold the projection module together and lift up the top part of the module.

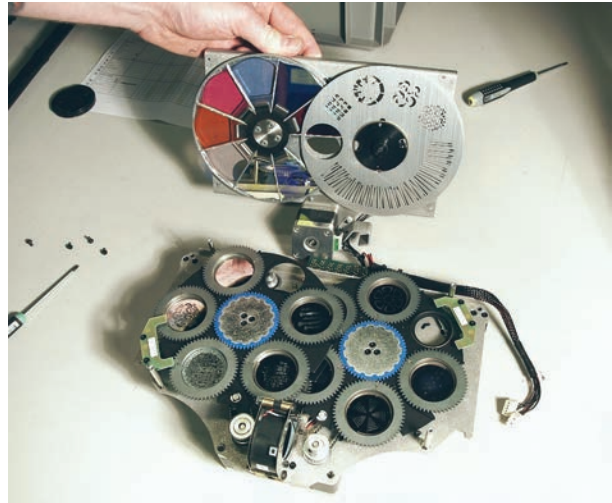
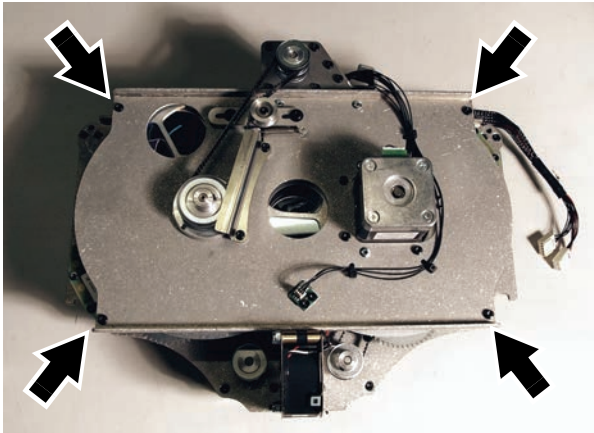

Figure 26: Opening the projection module

7. See Figure 27. Use a small flat-headed screwdriver to lever the retaining circlip **A** away from the FX wheel hub to release the wheel. Avoid bending the FX wheel during removal and storage.

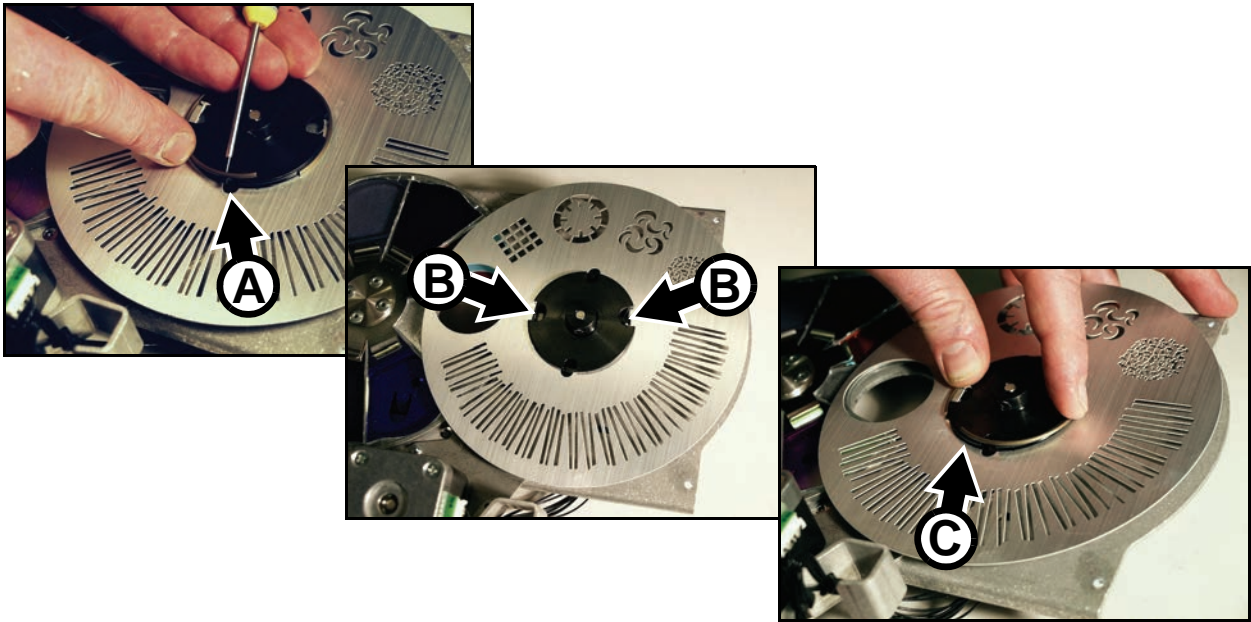

Figure 27: FX wheel removal and mounting

8. When installing an FX wheel, check first that the wheel is perfectly flat.
9. Note that the locating tabs **B** are tapered to match cutouts in the hub. Place the wheel on the hub and press the retaining circlip over the hub **C** until it snaps into place and holds the FX wheel securely.
10. Reassemble and reinstall the projection module going back through the removal procedure given above.
11. If no further service work is to be carried out, reinstall the head covers as described in “Access to the head” on page 17 and release the tilt lock before reapplying power.

Using the fixture

Before using the fixture, download and read the latest version of the MAC Viper Profile User Guide from the MAC Viper Profile Product Support page on the Martin website at www.martin.com. The User Guide contains details of:

- The effects available in the fixture.
- The control options available using DMX.
- The setup, monitoring and control options available using the onboard control and display panel.
- RDM (Remote Device Management) compatibility.
- Software service functions.

Applying power



Warning! Before applying power to the fixture:

- ***Carefully review the safety information starting on page 4.***
- ***Check that the installation is safe and secure.***
- ***Check that the base is fastened securely so that the torque reaction when the head is panned will not cause the base to move.***
- ***Check that the head tilt lock is released (see “Tilt lock” on page 6).***

To apply power, set the power on/off switch on the base to the “I” position.

When the fixture is powered up for the first time or after service, check lamp alignment as described on page 16.

Troubleshooting

Problem	Probable cause(s)	Remedy
One or more of the fixtures is completely dead.	No power to fixture.	Check that power is switched on and cables are plugged in.
	Fuse blown or internal fault.	Contact Martin™ Service or authorized service partner. Do not remove base or yoke covers, attempt to replace a fuse or carry out any repairs or service that are not described in this Safety and Installation Manual unless you have both authorization from Martin™ and official Martin™ service documentation.
Fixtures reset correctly but respond erratically or not at all to the controller.	Bad data link.	Inspect connections and cables. Correct poor connections. Repair or replace damaged cables.
	Data link not terminated.	Insert DMX termination plug in data output socket of the last MAC Viper Profile on the data link.
	Incorrect addressing of fixtures.	Check fixture address and protocol settings.
	One of the fixtures is defective and is disturbing data transmission on the link.	Unplug the XLR in and out connectors and connect them directly together to bypass one fixture at a time until normal operation is regained. Have the fixture serviced by a qualified technician.
Timeout error after fixture reset.	Effect requires mechanical adjustment.	Contact Martin™ Service or authorized Martin™ service partner.
Mechanical effect loses position.	Mechanical train requires cleaning, adjustment, or lubrication.	Contact Martin™ Service or authorized Martin™ service partner.
No light and lamp error message displayed.	Lamp blown	Disconnect fixture from power and replace lamp.
	Lamp not installed	Disconnect fixture from power and install lamp.
	Lamp access door safety switch open	Check that lamp access door is fully seated and locked in place.
Lamp cuts out intermittently.	Fixture is too hot.	Allow fixture to cool. Clean fixture. Reduce ambient temperature.

Table 2: Troubleshooting

Specifications

Physical

Length (base)	472 mm (18.6 in.)
Length (head)	566 mm (21.6 in.)
Width	472 mm (18.6 in.)
Width (base)	335 mm (13.2 in.)
Height (head straight up)	731 mm (28.8 in.)
Height (maximum)	748 mm (29.4 in.)
Weight	36 kg (79.4 lbs.)
Minimum center-to-center distance in side-by-side installation	650 mm (25.6 in.)

Lamp

Type	1000 W short-arc discharge
Approved lamp	Osram HTI 1000/PS Lok-it
Color temperature	6000 K
CRI (Color rendering index)	>85
Average lifetime	750 hours
Socket	PGJ28 Lok-it
Ballast	Electronic

Dynamic Effects

Color mixing	CMY, independently variable 0 - 100%
Color temperature control	CTO, variable 6000 - 3200 K
Color wheel	8 interchangeable dichroic filters + open, indexing, continuous rotation, random color
Aerial wheel	5 interchangeable aerial effects + open, indexing, continuous rotation and shake
Breakup wheel	5 interchangeable breakup/texture gobos + open, indexing, continuous rotation and shake
FX wheel	Interchangeable, gobo animation effects and integral gobos
Prism	Interchangeable 4-facet rotating prism
Iris	0 - 100%, pulse effects
Dimmer/shutter	0 - 100% continuous dimming, regular and random strobe and pulse effects, instant open and blackout
Dimming options	Choice of four dimming curves
Focus	Range varies with zoom angle, from 2 m (6.6 ft.) / 6 m (19.7 ft.) to infinity (approx.)
Zoom	10° - 44°
Pan	540°
Tilt	268°
Position correction system	Absolute position monitoring

Control and programming

DMX channels	26/34
Setting and addressing	Control panel with backlit graphic display and jog wheel or via DMX
16-bit control	Aerial, breakup and texture effect rotation and indexing, focus, zoom, pan and tilt
DMX compliance	USITT DMX512-A
RDM compliance	ANSI/ESTA E1.20
Receiver	Opto-isolated RS-485
Firmware update	USB memory device or USB/DMX hardware interface over DMX link

Construction

Color	Black
Housing	UV-resistant fiber-reinforced composite
Reflector	Glass, cold light
Protection rating	IP20

Installation

Mounting points	Eight 1/4-turn locking points, octagonal layout
Orientation	Any
Minimum distance from illuminated surface	1.6 m (5.2 ft.)
Minimum distance from combustible materials	0.3 m (12 in.)

Connections

AC power input	Neutrik PowerCon socket (accepts NAC3FCA connector)
DMX and RDM data in/out	5-pin locking XLR
USB memory devices	USB host socket

Electrical

AC power	120-240 V (nominal), 50/60 Hz
Power supply	Auto-ranging electronic switch-mode
Typical half-cycle RMS inrush current	16.2 A

Typical power and current

120 V, 60 Hz	1225 W, 10.3 A, PF 0.999
208 V, 60 Hz	1190 W, 5.8 A, PF 0.996
230 V, 50 Hz	1186 W, 5.2 A, PF 0.994
240 V, 50 Hz	1194 W, 5.0 A, PF 0.993

Measurements made at nominal voltage. Allow for a deviation of +/- 10%.

PF = power factor

Thermal

Maximum ambient temperature (T_a)	40° C (104° F)
Maximum surface temperature, steady state, $T_a = 40° C$	150° C (302° F)
Cooling	Filtered forced air (temperature-regulated, low noise)
Total heat dissipation (calculated, +/- 10% at 120 V, 60 Hz)	4180 BTU/hr

Approvals



EU safety	EN 60598-2-17 (EN 60598-1), EN 62471
EU EMC	EN 55015, EN 55103-1, EN 55103-2, EN 61547
US safety	UL 1573
US EMC	FCC Part 15 Class A
Canadian safety	CSA E598-2-17 (CSA E60598-1)
Canadian EMC	ICES-003 Class A
Australia/NZ	C-Tick N4241

Included items

Osram HTI 1000/PS Lok-it lamp	P/N 97010346
2 omega clamp attachment brackets with quarter-turn fasteners	2 x P/N 91602001
Safety and Installation Manual	P/N 35000258

Accessories

Power cable, AWG12, SJT, with Neutrik PowerCon NAC3FCA input connector, 3 m (9.8 ft.)	P/N 11541503
Neutrik PowerCon NAC3FCA power input connector (cable mount, blue)	P/N 05342804
Omega clamp attachment bracket with 1/4-turn fasteners	P/N 91602001
T-shaped omega clamp attachment bracket with 1/4-turn fasteners	P/N 91602008
Half-coupler clamp	P/N 91602005
G-clamp (suspension with yoke vertically downwards only)	P/N 91602003
Quick-trigger clamp (suspension with yoke vertically downwards only)	P/N 91602007
Safety wire, safe working load 50 kg	P/N 91604003
Double flightcase for 2 x MAC Viper	P/N 91510180

Spare parts

Osram HTI 1000/PS Lok-it lamp	P/N 97010346
-------------------------------	--------------

Related Items

Martin USB Duo™ USB-DMX Interface Box	P/N 90703010
---------------------------------------	--------------

Ordering information

MAC Viper Profile™ in cardboard packing case P/N 90233000
MAC Viper Profile™ in double flightcase P/N 90233010

Specifications subject to change without notice. For the latest product specifications including photometric data, see www.martin.com

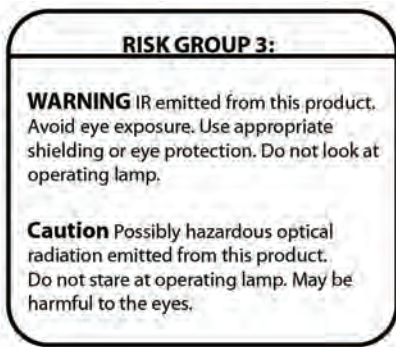

Photobiological Safety Warning

The label shown on the left is displayed on this product. If it becomes difficult or impossible to read, it must be replaced using the illustration on the left to reproduce a new label.

FCC Compliance

This device complies with Part 15 of the FCC Rules. Operation is subject to the following two conditions: (1) This device may not cause harmful interference, and (2) this device must accept any interference received, including interference that may cause undesired operation.

Canadian Interference-Causing Equipment Regulations - *Règlement sur le Matériel Brouilleur du Canada*

This Class A digital apparatus meets all requirements of the Canadian Interference-Causing Equipment Regulations.

Cet appareil numérique de la classe A respecte toutes les exigences du Règlement sur le Matériel Brouilleur du Canada.

Intellectual Property Rights

Martin™ MAC Viper™ products are covered by one or more of these patents:

CN101430070; CN101430073; CN101430080; CZ17567U; DE60009334.4; EP1234197; EP1234197;
EP1234197; US6,687,063; US7,498,756; US7,703,948; US7,789,543; US7,905,630; US7,942,535; US7,990,673;

and/or one or more of these patent applications:

CN101430076; CN101431847; EP2058589; EP2091302; EP2113714; EP2117284; EP2136136; EP2326150;
WO2011/100972; DKPA201270060; DKPA201270123; DKPA201270072;

and/or one or more other intellectual property rights, including one or more intellectual property rights listed on www.martin.com/ipr

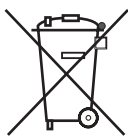

Disposing of this product

Martin™ products are supplied in compliance with Directive 2002/96/EC of the European Parliament and of the Council of the European Union on WEEE (Waste Electrical and Electronic Equipment), as amended by Directive 2003/108/EC, where applicable.

Help preserve the environment! Ensure that this product is recycled at the end of its life. Your supplier can give details of local arrangements for the disposal of Martin products.

This product contains a lithium battery. Ensure that it is disposed of correctly and responsibly by an authorized recycling or waste disposal center at the end of its life. Where applicable, Martin participates in schemes whose aim is to ensure that local recycling and/or waste disposal centers accept batteries from Martin products.



www.martin.com • Olof Palmes Allé 18 • 8200 Aarhus N • Denmark
Tel: +45 8740 0000 • Fax +45 8740 0010