



CONTROL SYSTEMS



12 Channel Rack Mount



6 Channel Rack Mount



12 Channel Wall Mount



6 Channel Wall Mount



12 Channel Wall Mount  
Hardwired



6 Channel Wall Mount  
Hardwired



## Advanced Power System

# User Manual

LSC Control Systems ©  
+61 3 9702 8000  
[info@lsccontrol.com.au](mailto:info@lsccontrol.com.au)  
[www.lsccontrol.com.au](http://www.lsccontrol.com.au)



V4.03  
December 2025

## **Disclaimer**

LSC Control Systems Pty Ltd has a corporate policy of continuous improvement, covering areas such as product design and documentation. To achieve this goal, we undertake to release software updates for all products on a regular basis. In light of this policy, some detail contained in this manual may not match the exact operation of your product. Information contained in this manual is subject to change without notice.

In any event, LSC Control Systems Pty Ltd cannot be held liable for any direct, indirect, special, incidental, or consequential damages or loss whatsoever (including, without limitation, damages for loss of profits, business interruption, or other pecuniary loss) arising out of the use or the inability to use this product for its intended purpose as expressed by the manufacturer and in conjunction with this manual.

Servicing of this product is recommended to be carried out by LSC Control Systems Pty Ltd or its authorised service agents. No liability will be accepted whatsoever for any loss or damage caused by service, maintenance or repair by unauthorised personnel. In addition, servicing by unauthorised personnel may void your warranty.

LSC Control Systems' products must only be used for the purpose for which they were intended.

Whilst every care is taken in the preparation of this manual, LSC Control Systems takes no responsibility for any errors or omissions.

## **Copyright Notices**

"LSC Control Systems" is a registered trademark.

lsccontrol.com.au is owned and operated by LSC Control Systems Pty Ltd.

All Trademarks referred to in this manual are the registered names of their respective owners.

The operating software of the APS and the contents of this manual are copyright of LSC Control Systems Pty Ltd © 2021.

All rights reserved.

## **Contact Details**

LSC Control Systems Pty Ltd

ABN 21 090 801 675

65-67 Discovery Road  
Dandenong South, Victoria 3175 Australia  
Tel: +61 3 9702 8000

email: [info@lsccontrol.com.au](mailto:info@lsccontrol.com.au)

web: [www.lsccontrol.com.au](http://www.lsccontrol.com.au)

## Contents

<b>1</b>	<b>Introduction.....</b>	<b>5</b>
1.1	About this Manual.....	5
1.1.1	Conventions Used in this Manual .....	5
1.2	Overview and Features.....	5
1.3	Models/Options.....	7
1.3.1	Rackmount APS .....	7
1.3.2	Wallmount APS .....	7
<b>2</b>	<b>Quick Start Guide.....</b>	<b>8</b>
2.1	APS Channel Switching.....	9
2.1.1	Stopping Automatic Shutdown.....	9
<b>3</b>	<b>Installation .....</b>	<b>10</b>
3.1	Safety.....	10
3.2	Unpacking .....	10
3.3	Mounting the APS.....	10
3.3.1	Rackmount APS .....	10
3.3.2	Wallmount APS .....	10
3.4	Connections .....	12
3.4.1	Input Power Supply .....	12
3.4.2	DMX Input (and GPI).....	12
3.4.3	DMX Thru (and GPO).....	12
3.5	Power Outputs and Phasing .....	13
<b>4</b>	<b>Front Panel .....</b>	<b>14</b>
<b>5</b>	<b>Configuration and Operation .....</b>	<b>15</b>
5.1	Overview .....	15
5.2	Help Screens.....	16
5.3	Channel Configuration / Operating Modes.....	16
5.4	Set To DMX.....	17
5.4.1	View DMX.....	18
5.5	Set to Off .....	18
5.6	Set To On.....	19
5.7	Set To APS.....	19
5.7.1	DMX Presence .....	19
5.7.2	GPI.....	19
5.7.3	Stand Alone Mode .....	20
5.7.4	Manual Mode.....	21
5.8	RDM Control.....	21
5.9	Emergency Mode .....	21

5.10	Configuration Menu .....	21
5.11	Timing .....	22
5.11.1	Stagger Power On .....	22
5.11.2	Power Off Delay .....	22
5.11.3	Warning Beep .....	23
5.12	Limits .....	23
5.12.1	Removing Limits .....	24
5.12.2	Default Limits .....	24
5.13	System .....	25
5.13.1	Code (Software) Upgrade .....	25
5.13.2	Reset .....	25
5.13.3	Colour Theme .....	26
5.13.4	Import Export .....	26
5.13.5	Service .....	26
5.14	About .....	26
5.14.1	Owner .....	26
5.15	Lock / Unlock .....	27
<b>6</b>	<b>RDM .....</b>	<b>28</b>
6.1	Overview .....	28
6.2	APS RDM Commands .....	28
<b>7</b>	<b>HOUSTON X .....</b>	<b>29</b>
<b>8</b>	<b>Maintenance and Troubleshooting .....</b>	<b>29</b>
8.1	Maintenance .....	29
8.2	Tripped Breakers .....	29
<b>9</b>	<b>Specifications and Output Options .....</b>	<b>30</b>
9.1	Rackmount APS .....	30
9.2	Wallmount APS .....	31
9.3	Wieland Pinouts .....	33
9.4	Socapex Pinouts .....	33
<b>10</b>	<b>Feature History .....</b>	<b>33</b>
<b>11</b>	<b>Compliance Statements .....</b>	<b>35</b>

## 1 Introduction

### 1.1 About this Manual

This manual describes the installation, configuration and operation of the APS (Advanced Power System) intelligent power distribution unit manufactured by LSC Control Systems.

There are four different colour themes that you can select on the APS touch screen. The screen images in this manual use the default “Gothic” colour theme.

#### 1.1.1 Conventions Used in this Manual

Throughout this manual, certain conventions have been used to make the meaning clearer.

- A word in **Bold** text represents a virtual button on the press screen.
- Emphasis is indicated by underlining.
- *Notes or Hints are displayed in italic font*

### 1.2 Overview and Features

The APS (Advanced Power System) is a power switching and distribution unit with a 3 phase mains input (single phase input available) and either 6 or 12 single phase switched outputs depending upon the model.

Being a power control and distribution unit, the APS is equally at home in a variety of permanent and touring applications including (but certainly not limited to),

- Moving Lights
- LED fixtures
- Video walls
- Audio Systems
- Stall power for Markets and Fairgrounds

Power Distribution is the most critical components of any system and lighting is no exception particularly these days when almost every fixture now needs its own mains power source. However, with each fixture needing power, new problems are introduced particularly during the power up sequence.

Firstly, in-rush currents of all the power supplies and lamps starting up at the same time often causes main breakers to trip and secondly the transient currents drawn by the power supplies can cause earth protection breakers to trip. To avoid these effects, you require complicated power up sequences usually requiring a human sitting there switching circuits on one at a time.

The APS units are a solution to this and other problems by using internal relays to switch the power and controlling the power-on sequence of each of the individual output circuits. In its simplest form, a single command starts the sequence and then each of the 12 outputs is turned on, one output at a time, with a programmable time before the next circuit turns on. In this way the peak current drawn is always low and upstream breakers should not trip.

In addition, nuisance circuit breaker tripping is overcome by the APS by switching on the relay as the mains voltage passes through the zero point of the sine wave, thus providing a pseudo soft-start.

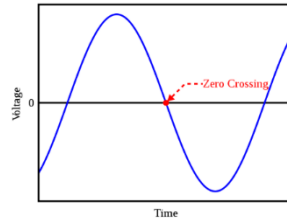

APS units can be connected together where more than 12 circuits are required and the units automatically cascade. That is, the second unit won't commence its start-up sequence until the first has finished.

One of the potentially most expensive faults that you might encounter is a “dropped” Neutral on the mains supply. If you connect your video, lighting or audio rig to power and turn it on and the Neutral is missing, you can potentially get 415V across all connected devices and the result can be catastrophic. The APS internal electronics are designed to run at 415V without causing damage so they can tolerate a missing neutral. When the APS powers up, it does not energise any of the outputs until it has measured the voltages on all phases and checked they are within safe working limits. If they are not, then it will not switch on the outputs (no matter what you tell it to do) and instead displays a large error message. Similarly, if the Neutral fails mid show, then the APS will disconnect power within 50mS, therefore minimising damage to attached equipment.

The APS measures both incoming voltage and frequency and uses this information to delay the power-up sequence until they have stabilised. This is of particular importance if your power is being supplied from a generator. In addition, because the loads are sequentially switched on, there is no sudden large load presented to the generator which increases the stability of the generator output.

The APS is also ideal for permanent installations such as schools, churches, public halls and other venues where Energy Management is a key goal. By using the “APS” mode to power all the lighting and video system, the lighting and video equipment will be automatically and sequentially powered up over a few seconds when the lighting console is turned on (and DMX is detected) without any user intervention. At the end of the session, after the lighting console is turned off all the LED fixtures, video screens and moving lights will automatically be switched off a few minutes. A truly green solution.

The APS includes the following features:

- Automatic control via DMX512. The presence of DMX sequentially turns outputs on and loss of DMX turns outputs off after a pre-set time delay
- Remote GPI contact closure (if DMX is not used) sequentially turns outputs on and open contact turns outputs off after a pre-set time delay
- Remote On/Off switching of individual output circuits via DMX512
- “Stand Alone” mode for automatic On/Off of output circuits whenever input power is present
- Manual override (On/Off of output circuits) via front panel press screen (with user lock out)
- Control via RDM
- Control and monitoring via Houston X
- RCBO (Residual Current Breaker with Overcurrent) output channel circuit breakers protect against current overload AND earth leakage faults. Also known as RCD (Residual Current Device) or GFI (Ground Fault Indicator)
- RCBO output channel circuit breakers also provide Neutral Disconnect function

- Staggered switch on of outputs (with adjustable delay) to prevent start-up surge overloading of the power supply feed
- Multiple APS units can be configured to start up in sequence
- Cascading start-up for individual units via XLR5 cabling and/or based on unit number
- Input voltage monitoring (RMS) per phase with over voltage switch off
- Input current monitoring (RMS) per phase
- Dropped neutral protection with almost instant load disconnect
- Input mains frequency monitoring
- Programmable over-voltage and under-voltage trips to protect loads. Voltage and current reporting via RDM
- Three phase operation
- Single phase operation possible but input current must be limited to 63A in total

## **1.3 Models/Options**

### **1.3.1 Rackmount APS**

The Rackmount APS is available in the following sizes,

- 12 channels x 10 Amp outputs
- 12 channels x 16 Amp outputs (export only)
- 6 channels x 25 Amp outputs

Output connection options,

- Australian sockets
- Weiland sockets
- Socapex sockets
- CEE7 (Shuko) sockets
- Powercon connectors (2 variants available)
- Terminals (for permanent installations)
- Socapex sockets plus 3 “powerCon True1Top” connectors in parallel with channels 1-3 of the Socapex. This combination of outputs is designed for video wall users who can power the video screen panels via the Socapex outputs but also have 3 powerCon connectors for media servers, ethernet switches, etc, all protected by the APS.

See section 9.1 for details on input and output connection options.

### **1.3.2 Wallmount APS**

The Wallmount APS is available in the following sizes,

- 12 channels x 13 Amp outputs
- 6 channels x 25 Amp outputs

Output connection options,

- Front panel 12 X 15 Amp Australian GPO outlets
- Front panel 6 X paired (20A + 15A per channel) Australian GPO outlets
- Internal terminals (for permanent installations)

See section 0 for details on input and output connection options.

## 2 Quick Start Guide

Every output channel can be individually configured to operate in any of the following modes:

- **APS.** The channels are sequentially switched on when triggered. There are several methods of triggering the “switch on” sequence as described below.
- **DMX.** The channel is switched by the level of the DMX slot (address) of the selected control source to which it is patched. This is the equivalent of a DMX controlled switch. See section 5.4
- **OFF.** Always Off.
- **ON.** Always On.

To change the configuration of a channel, press anywhere on the **home screen** to reveal the “Configuration Menu” then press **Chan Config**.

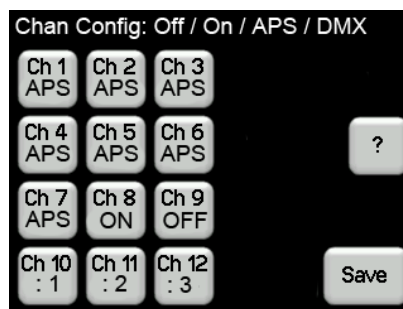

Each channel button shows its current configuration setting. Channels set to DMX show the DMX slot number to which they are patched.

Select the channels to configure by pressing their numbers. Selected channels turn dark grey. When any channel has been selected the “Config” button appears. For example, if channel 1 and 2 was selected....

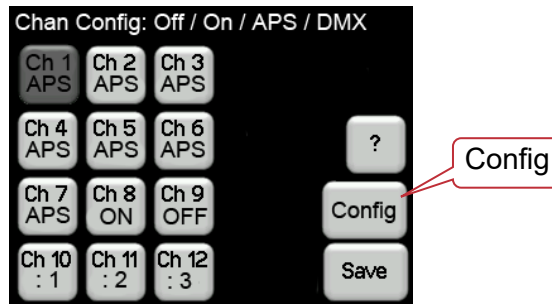

Press **Config**,

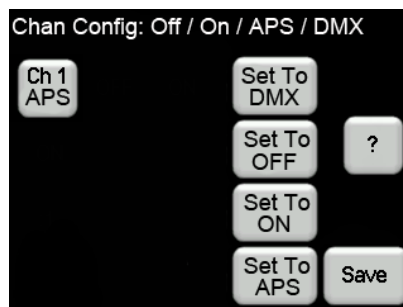

Press the desired configuration for the selected channel(s) then press **Save**.

## 2.1 APS Channel Switching

All channels set to APS (above) can be sequentially switched on via any of the following methods.

- DMX presence. The APS will start its staggered switch on sequence of channels that are set to “APS” whenever a DMX signal is detected. In this mode, the APS does not use a DMX slot (address) and is not controlled by DMX levels. It only responds to the presence or absence of DMX. When the DMX is no longer present (when the lighting controller is switched off) the APS will switch off all channels after the adjustable “Power Off Delay” time. See 5.7.1
- GPI (General Purpose Input). The APS will start its staggered switch on sequence of channels that are set to “APS” when a contact closure is detected on the GPI connector. See 5.7.2
- Standalone mode. The APS will start its staggered switch on sequence of channels that are set to “APS” mode 3 seconds after power is applied at the input. To select “stand alone” mode, press anywhere on the **Home Screen** then **Stand Alone, Enable**. See 5.7.3
- Manual Mode. If the APS controlled outputs are OFF, press anywhere on the **Home Screen**, then **Manual APS On**. This starts the switch-on sequence of “APS” channels. If the APS controlled outputs are ON, pressing anywhere on the **Home Screen** then **Manual APS Off** switches off all “APS” channels after you say “yes” to a confirmation warning. See 5.7.4

### 2.1.1 Stopping Automatic Shutdown

If the APS about to turn off and you want to keep it on, press the screen to postpone the shutdown countdown then press anywhere on the **Home Screen** then press **Stand Alone**, then **Enable**.

## 3 Installation

### 3.1 Safety

All electrical work must be carried out by suitably qualified persons.

### 3.2 Unpacking

The APS is fully tested and inspected before leaving the factory. Upon delivery, inspect the APS for signs of damage or mishandling. In the event of any damage, contact your LSC agent.

### 3.3 Mounting the APS

#### 3.3.1 Rackmount APS

The Rackmount APS is designed for mounting in a standard 19 inch rack. It occupies 3RU (Rack Units) of space.

#### 3.3.2 Wallmount APS

The wall-mount version is comprised of two sections. The front section (containing all of the electronics) is attached to the rear section by two hinges located at the bottom and the front section can be completely detached from the rear section to allow better access to the mounting points and the supply and load cable terminations. This also allows the rear section to be mounted and connected whilst the front section is safely stored until all other trades have completed their work and the area is safe and clean.

The front section can be opened by removing the 4 large screws as indicated below.



To completely detach the front section, remove the 4 large screws as shown then unfold the front section. Use a 10mm spanner to remove the 2 nuts holding the metal support straps and lift the straps off the bolts. Replace the nuts to retain the fibre washers. Carefully unfold the front section to the fully open position.

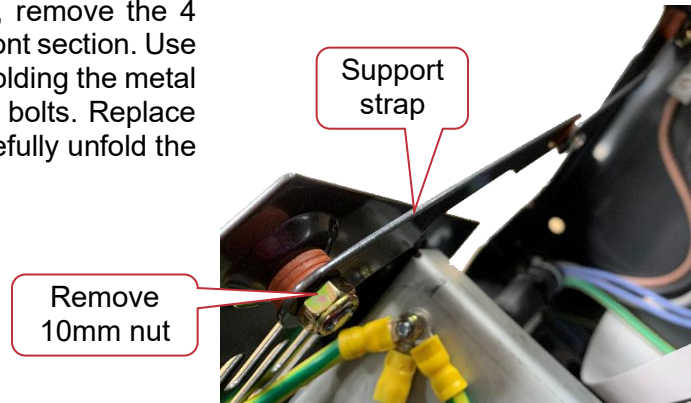

Disconnect the 3-phase cable to the front section from the input terminal block on the rear section and un-bolt the earth connection. Cut the cable tie that secures the 3-phase input cable

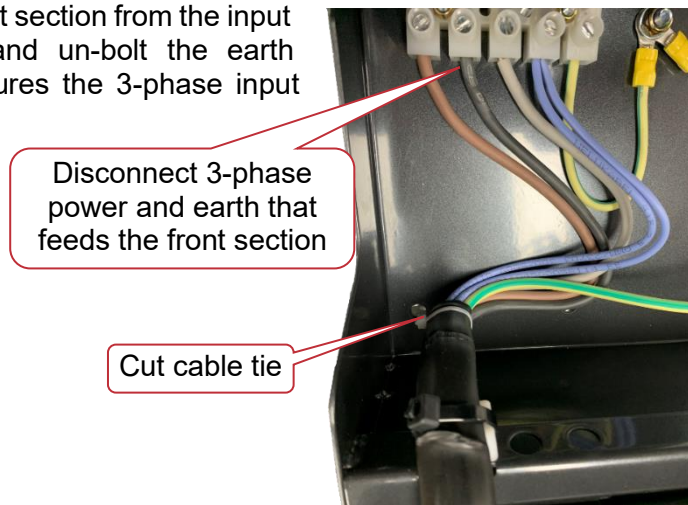

**For hardwired output versions only**

**10-Amp output versions**

Un-plug the load connector plugs from the load terminal blocks on the rear section. These connections are tight and will need to be prised out.

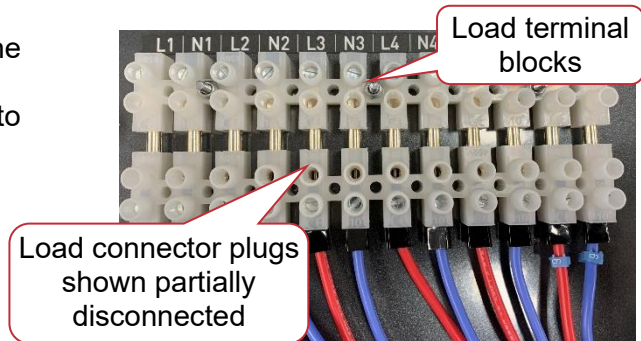

**25-Amp output versions**

Remove the load terminal block by undoing the nuts that secure the terminal block to the rear section.

The front section can now be removed from the rear section by sliding it sideways off the split hinges.

The rear section has provisions for mounting to walls and other upright structures such as uni-strut. Mounting brackets for P1000 Uni-Strut are available from LSC.

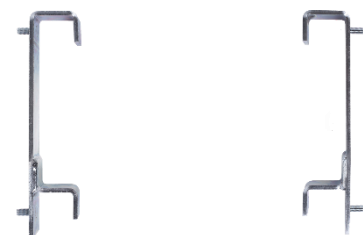

**Uni-Strut brackets**

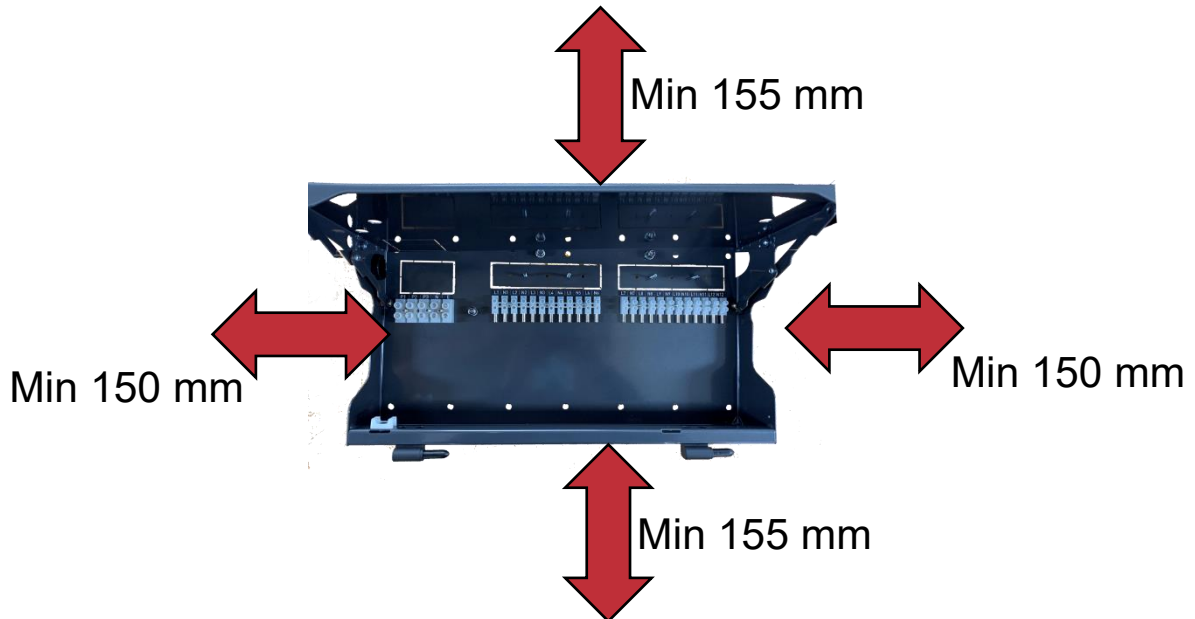

**APS Wall Mount Rear Section**

Allow a minimum of 150mm clearance on either side and 155mm vertical clearance to allow units above and below to be opened.

The wall mount APS weighs 16Kgm.

**3.4 Connections**

**3.4.1 Input Power Supply**

The APS must be fed from a suitable external circuit breaker.

The nominal input voltage is 220-240 Volts. 3-phase Star (380-415V). 50-60Hz. Single phase operation is possible but input current must be limited to 63A in total.

**3.4.2 DMX Input (and GPI)**

A 5 pin XLR is provided for DMX input. Two modes of DMX operation are possible.

- DMX Presence. The switch on sequence is started whenever DMX is detected on the DMX input.
- DMX Control. Channels set to “DMX” are controlled by the DMX level of the DMX slot to which they are patched.

See section 5.7

The DMX Input connector is also used for a GPI (General Purpose Input). If DMX is not being used to automatically control an APS, then the APS can be remotely switched on (starting its standard switch-on sequence) by providing a contact closure between pins 1 and 4 of the DMX Input connector. When the contact closure is opened, the APS will switch off all channels after the adjustable delay time

**3.4.3 DMX Thru (and GPO)**

A 5 pin XLR is provided for DMX Thru (output). The DMX Thru connector is primarily provided to feed the DMX signal to another APS unit. The APS will automatically connect the DMX input to the DMX Thru at the completion on the switch on sequence when all 12 outputs have been switched on. This provides an automatic method of sequentially switching on multiple APS units. When the outputs of an APS are switched off (either automatically by the loss of DMX or manually via the press screen) the feed of DMX to the DMX Thru connector is also switched off.

The DMX Thru connector is also used as a GPI output. This is provided to feed a GPI signal to another APS unit. The APS will automatically provide a contact closure between pins 1 and 4 of the DMX Thru connector at the completion on its switch on sequence (when all 12 outputs have been switched on). If the GPI output is connected to the GPI input of the next APS, then multiple APS units can be sequentially controlled by a single switch connected to the first APS.

When the outputs of an APS are switched off, the contact closure on the DMX Thru connector is also switched off. This will therefore automatically switch off any APS connected to the DMX Thru (GPI output).

### **3.5 Power Outputs and Phasing**

The outputs are fed from the following input power phases.

<b>Output</b>	<b>Input Phase</b>
1	1
2	2
3	3
4	1
5	2
6	3
7	1
8	2
9	3
10	1
11	2
12	3

The input phase number for each output is also shown on the front panel below each output circuit breaker.

The output connections and the pin-outs of the multi-pin sockets are listed in section 1.

## 4 Front Panel

The front panel contains the RCBO (Residual Current Breaker with Overcurrent) circuit breakers for each output. The number below each circuit breaker shows which input phase feeds that output channel.

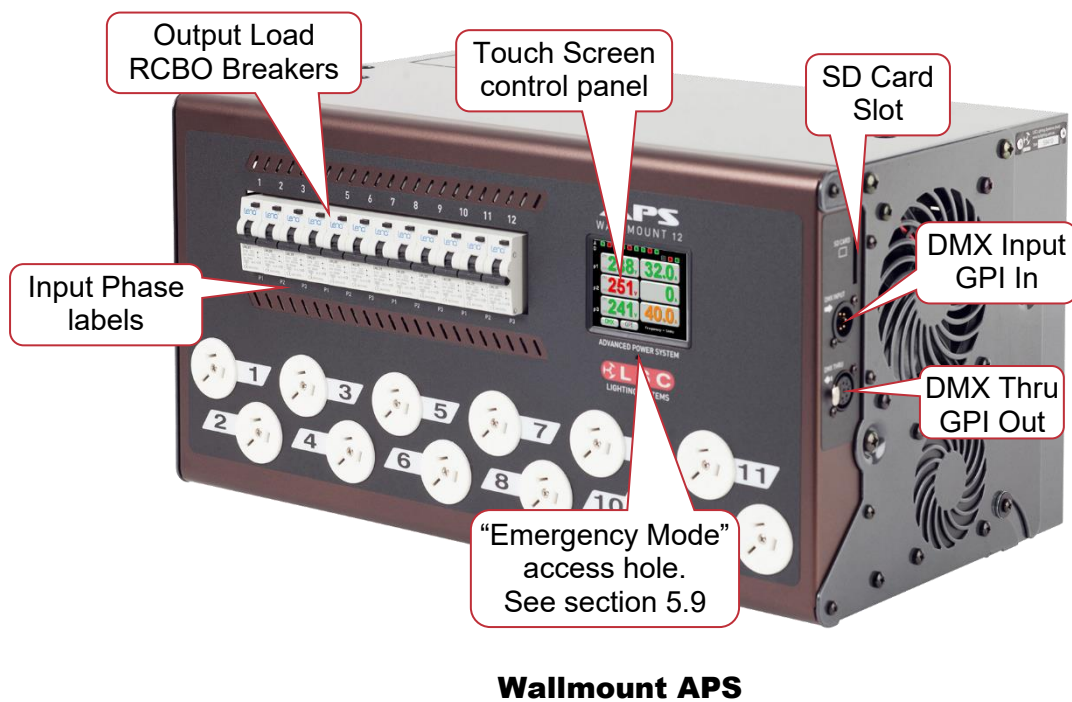
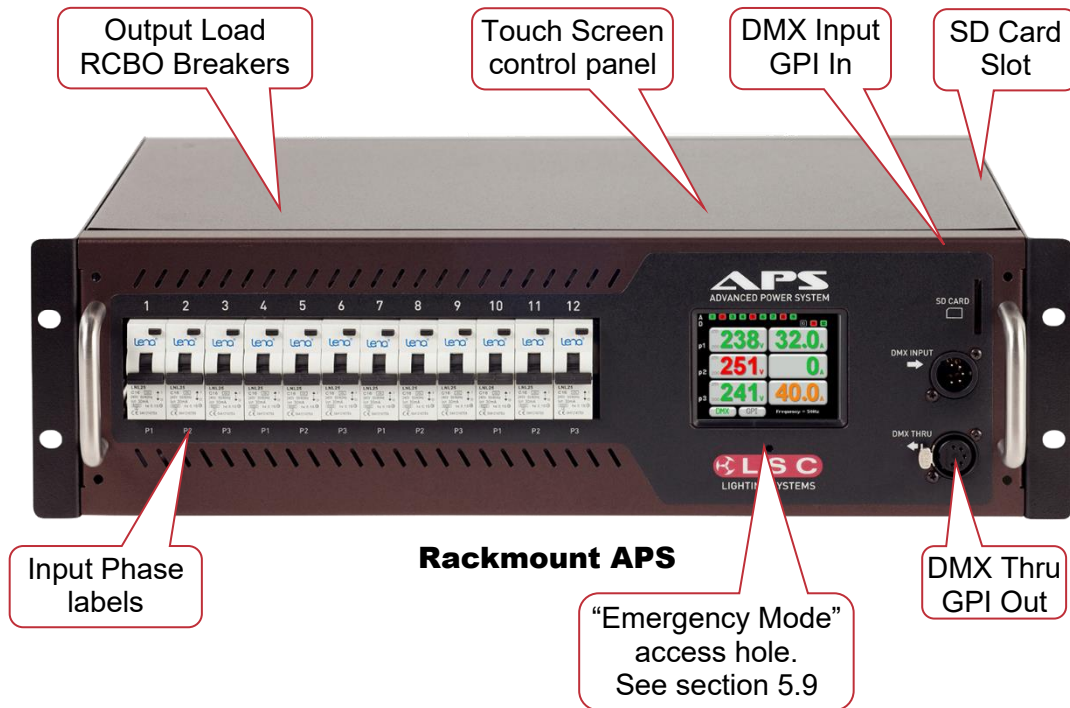

## 5 Configuration and Operation

### 5.1 Overview

The APS uses a colour LCD touch screen which is operated by pressing the virtual buttons with your finger or a stylus. Do not use sharp objects to operate the touch screen.

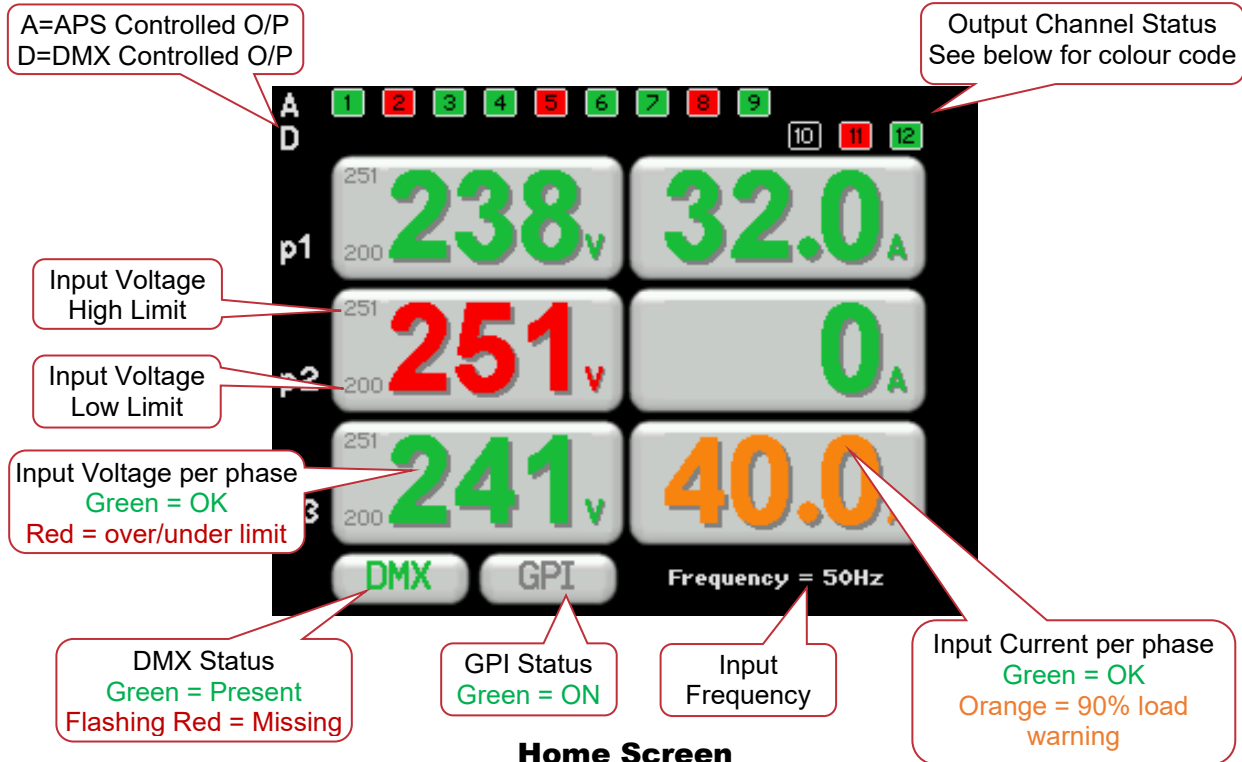

#### Home Screen

Touch anywhere on the “Home Screen” to access the “Configuration Menu”.

The output channel status icons at the top of the home screen have two rows, A and D.

- Channels in the “A” row are controlled by the APS. See section 5.7
- Channels in the “D” row are controlled by the DMX slot to which they are patched. See section 5.4

The output channel status icons also show the current status of each output.

- **Green** = The channel is on via APS or DMX control
- **Black** = The channels is off via APS or DMX control.
- **Blue** = The channel is always on
- **X** = The channel is always off
- **Red** = The channel has been automatically turned “Off” due to an over or under voltage input.
- **Orange** = The channel has been automatically turned “Off” due to an over or under voltage input but the input voltage is now within limits and the channel is about to automatically turn back on if the voltage stays with limits for 10 seconds.

The “Input Voltage High Limit” and “Input Voltage Low Limit” per phase can be set. If these limits are exceeded, the outputs connected to that phase will be switched off and their input voltage displays will turn to red. See section 5.12.

The input current per phase is displayed in green. The readout turns orange as a warning when the input current reaches 90% of the maximum allowable current per phase.

*Note: This reading is the total input current per phase. The maximum current per output channel is determined by the capacity of its front panel RCBO circuit breaker and is preset in the factory.*

The DMX status is green when DMX is present and flashes red when DMX is not present.

The GPI status is green when a GPI signal (contact closure) is present on pins 1 and 4 of the “DMX Input” connector. See section 5.7.2

If the outputs are manually turned on or off from the touch screen (Manual APS On/Off), then the DMX and GPI status indicators are replaced by a “Manual Mode” indicator. See section 5.7.4

## 5.2 Help Screens

Some menus have “Help” screens available as indicated by a ? button in the top right corner of the touch screen. Press ? (when available) to see the help screen.

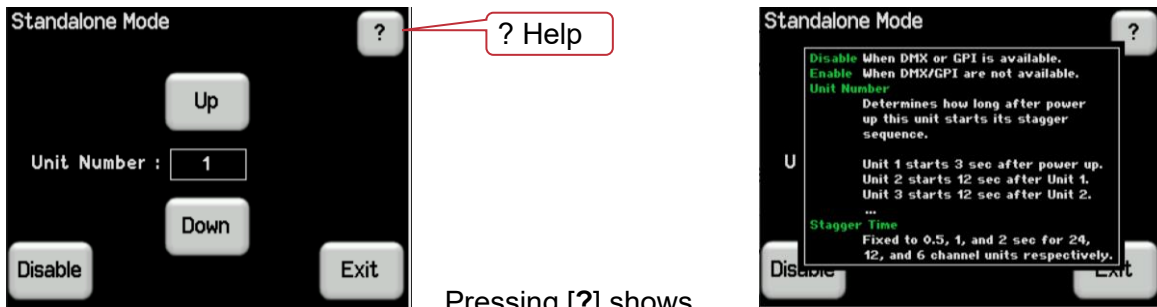

Pressing [?] shows.....

Press anywhere within the help screen to cancel.

## 5.3 Channel Configuration / Operating Modes

The APS uses internal relays to switch the power on and off on each output. Every output channel can be individually configured to operate in any of the following modes,

- **DMX**. The channel is switched by the DMX level of the slot to which it is patched. See section 5.4
- **OFF**. Always Off. See section 5.5
- **ON**. Always On. See section 5.6
- **APS**. The channels are sequentially switched on when triggered. There are several methods of triggering the switch on sequence. See section 5.7.

*Note: In the unlikely event that the APS does not respond to your commands, you can manually force the APS to switch on all of its outputs. See section 5.9*

*Note: The RCBO's (circuit breakers) on the front panel provide protection against current overload and excessive earth leakage. They are not designed to be used as an everyday switch due to the limited life expectancy of 1,000/2,000 cycles for an RCBO/MCB compared to >100,000 cycles for a relay or switch.*

To change the configuration of a channel, press anywhere on the **home screen** to reveal the “Configuration Menu” then press **Chan Config**.

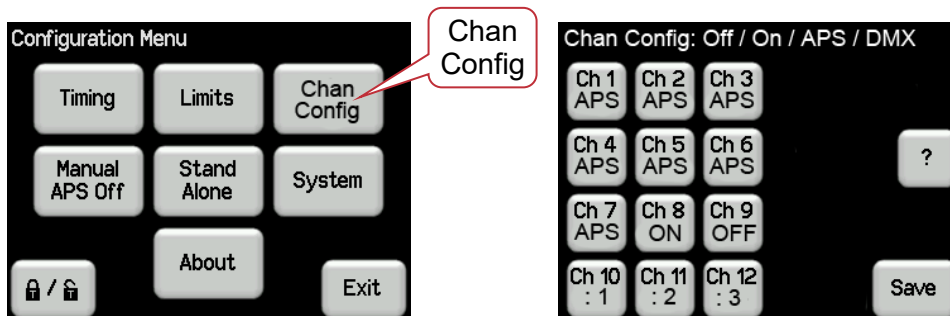

Each channel button shows its current configuration setting. Channels set to DMX show the DMX slot number to which they are patched.

Select the channels to configure by pressing their numbers. Selected channels turn dark grey. When any channel has been selected the “Config” button appears.

For example, if channel 1 was selected....

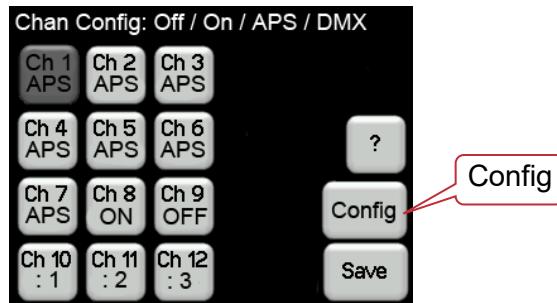

Press **Config**,

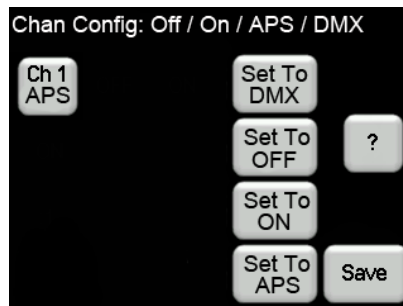

Press the desired configuration for the selected channel(s). The choices are,

- Set to DMX
- Set to OFF
- Set to ON
- Set to APS

Make your selection then press **Save**.

Each of these configurations are described below.

#### 5.4 Set To DMX

Channels set to “DMX” are controlled by the DMX level of the DMX slot to which they are patched. This is the equivalent of a DMX controlled switch. This feature was introduced in version 2.0 of the APS software. Units with earlier software can be upgraded to take advantage of this feature.

- A channel set DMX will switch ON when its DMX signal exceeds 60%
- A channel set DMX will switch OFF when its DMX signal drops below 40%.
- All Channels set to “DMX” are switched off when DMX is no longer present on the APS input (after the adjustable “Power Off Delay” time). See section 5.11.2.

*Note:* The “DMX Thru” connector only becomes active after the APS has completed the staggered switch on sequence of its APS channels. This means that the next APS unit, fed from to the DMX Thru connector, will only receive DMX after the current APS has finished its switch on sequence.

To control a channel by DMX, press anywhere on the **home screen** then press **Chan Config**. Select the channel(s) by pressing their numbers. Selected channels turn dark grey. Press **Config, Set To DMX**.

The “DMX Patch Setup” screen shows the APS channels set for DMX control and their DMX slot number if they have already been patched. To patch a channels (or change the DMX slot of an existing patch) press the channels to be patched (or changed) and the “Patch DMX” button appears.

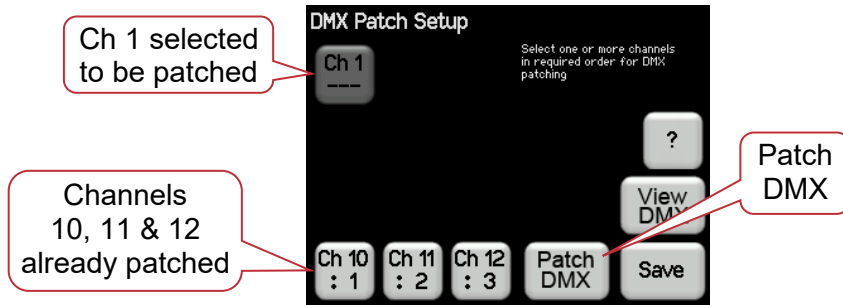

Press **Patch DMX**. The “Set DMX Address” keyboard appears.

Enter the DMX channel number to control this channel. Multiple APS channels can be selected and they will be patched in the order that they were selected to sequential DMX slots starting from the DMX slot number that you enter. A single DMX slot number can be patched to control multiple channels.

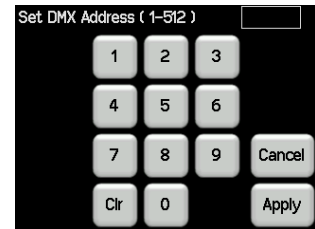

Press **Apply**.

### 5.4.1 View DMX

On the “DMX Patch Setup” screen (see above), pressing **View DMX** shows the channel levels of the DMX signal connected to the DMX input.

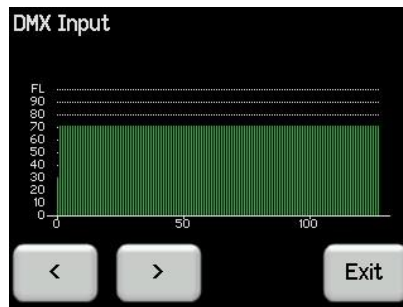

Press either > or < to scroll through the DMX channels.

### 5.5 Set to Off

Channels set to “OFF” are always off and cannot be turned on by the APS. The channel icon of OFF channels at the top of the home screen has a X.

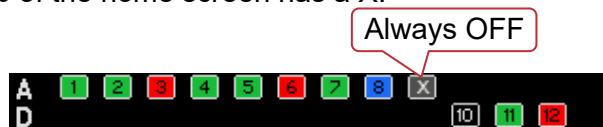

To set an APS channel to be always off, press anywhere on the **home screen** then press **Channel Config**. Select the channel(s) by pressing their numbers. Selected channels turn dark grey. Press **Set To OFF**, then **Save**.

## 5.6 Set To On

Channels set to “ON” are always on whenever power is applied to the APS. All control of the channel is ignored except that any ON channels will still turn off if the supply volts are outside the set limits. The channel icon of ON channels at the top of the home screen is blue.



To set an APS channel to be always on, press anywhere on the **home screen** then press **Channel Config**. Select the channel(s) by pressing their numbers. Selected channels turn dark grey. Press **Set To ON**, then **Save**.

## 5.7 Set To APS

Channels set to “APS” are switched on sequentially to minimise surge current. This is also known as a “staggered switch on”. The time delay between channels switching on can be set using the touch screen. See section 5.11.1.

To set a channel to APS control, press anywhere on the **home screen** then press **Channel Config**. Select the channel(s) by pressing their numbers. Selected channels turn dark grey. Press **Set To APS** then **Save**.

All APS controlled channels can be sequentially switched on via any of the following methods as described below,

- DMX presence. See 5.7.1
- GPI (General Purpose Input) contact closure. See 5.7.2
- Stand Alone Mode (presence of input power). See 5.7.3
- Manual Mode (using the touch screen). See 5.7.4

### 5.7.1 DMX Presence.

The switch on sequence is started whenever DMX is detected on the DMX INPUT. In this mode, the APS does not use a DMX slot (address) and is not controlled by DMX levels. It only responds to the presence or absence of a valid DMX signal.

When multiple APS units are cascaded from “DMX THRU” to “DMX INPUT”, the DMX signal is not passed on to the “DMX THRU” connector until the APS has completed its switch on sequence thus delaying the DMX signal to the next APS. The next APS will then detect the DMX signal, switch on its channels and repeat the procedure.

When the DMX signal is no longer present (when the lighting controller is switched off) the APS will switch off all channels after the adjustable “Power Off Delay” time. See section 5.11.2

### 5.7.2 GPI.

The GPI function allows a single APS or multiple APS units to be remotely controlled by a single switch. Pins 1 and 4 of the “DMX INPUT” connector are used as a GPI (General Purpose Input). When a contact closure is detected between pins 1 and 4 of the “DMX INPUT” connector, the switch on sequence of the “APS” channels is started.

When multiple APS units are cascaded, pins 1 and 4 of the “DMX THRU” connector are used as a GPO (General Purpose Output) and connected to pins 1 and 4 of the “DMX INPUT” of the next APS. The APS “DMX THRU” connector will automatically provide a contact closure between pins 1 and 4 at the completion on its switch on sequence thus sending the contact closure to the next APS. The next APS will then detect the GPI signal and repeat the procedure.

When the contact closure between pins 1 and 4 of the “DMX INPUT” is opened the APS will switch off all channels after the adjustable “Power Off Delay” time and also open pins 1 and 4 of its DMX THRU connector thus switching off the next APS.

### 5.7.2.1 GPI Cables

To make a GPI input cable, connect a switch (contact closure) between pins 1 and 4 of a 5-pin female XLR plug and plug it into the DMX INPUT connector of the APS.

To make a GPI loop cable to connect the GPI THRU of one APS to the GPI INPUT on the next APS connect pins 1 and 4 of a 5-pin male XLR plug to pins 1 and 4 of a 5-pin female XLR plug respectively. You can also use commercially available DMX cables if they have pins 1 and 4 connected. DMX uses pins 1 (ground), 2 (- data) and 3 (+ data) however the DMX standard specifies pins 4 and 5 as an optional secondary data link so most DMX cables connect all 5 pins.

### 5.7.3 Stand Alone Mode

In standalone mode, the APS will automatically start its staggered switch on sequence of channels that are set to “APS” mode, 3 seconds after power is applied at the input.

To select “stand alone” mode, press anywhere on the **Home Screen** then press **Stand Alone, Enable.**

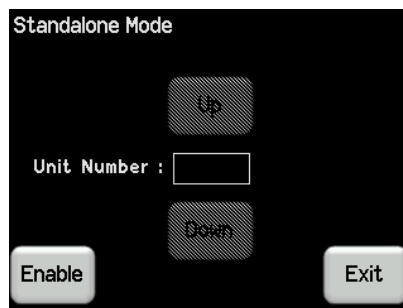

If multiple APS units are to be operated in Stand Alone Mode, you can prevent them from all starting their starting their staggered switch on sequence at the same time by assigning a different “unit number” to each APS.

Each unit number adds an additional 12 second delay to the start of the staggered switch on sequence.

- Unit 1 starts after 3 seconds.
- Unit 2 starts after 15 seconds.
- Unit 3 starts after 27 seconds etc.

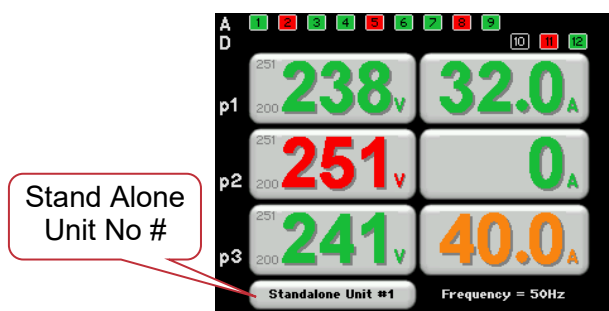

In standalone mode, the “Stagger Power On” times of the output channels are fixed to ensure that channels in different size APS units do not turn on at the same time.

- 6 channel APS units have a fixed stagger time of 2 seconds.
- 12 channel APS units have a fixed stagger time of 1 second.

### 5.7.4 Manual Mode.

If the APS controlled outputs are OFF pressing anywhere on the **Home Screen**, then **Manual APS On**, starts the switch-on sequence of “APS” channels.

If the APS controlled outputs are ON, pressing anywhere on the **Home Screen** then **Manual APS Off** switches off all “APS” channels after you say “yes” to a confirmation warning.

To exit manual mode, connect a DMX signal to the APS or trigger the GPI input.

### 5.8 RDM Control

Channels can also be remotely turned on or off by RDM. See section 6.2

### 5.9 Emergency Mode

In the unlikely event that the APS does not respond to your commands, you can manually force the APS to switch on all its outputs. There is a small hole located on the front panel below the touch screen. Inside there is a button which, when pressed with a small pin or paperclip, turns ON all outputs (simultaneously) and shuts down the APS monitoring and control system. The touch screen backlight remains on to show the presence of input power.



## WARNING.

Only use this method of turning on the APS channels as a last resort. The following action will turn the channels on, even if the system has shut down the output due to a dropped neutral or over voltage input. Be aware that taking this action may result in damage to any connected equipment.

The APS remains in this mode until input power is removed.

### 5.10 Configuration Menu

Press anywhere on the **Home Screen** to access the “Configuration Menu”.

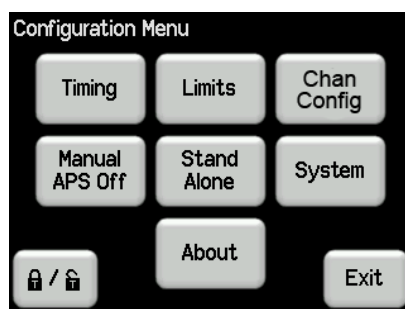

The configuration menu provides the following sub menus,

- Timing. See 5.11
- Limits. See 5.12
- Chan Config. See 5.3
- Manual APS On/Off. See 5.7.4
- Stand Alone. See 5.7.3
- System. See 5.13
- About. See 5.14
- Lock/Unlock. See 5.15

## 5.11 Timing

Pressing anywhere on the **Home Screen** then pressing **Timing** allows you to set the timing parameters.



### 5.11.1 Stagger Power On

When the command to switch on the outputs is executed, the outputs under APS control are sequentially switched on to avoid an excessive surge current on the power supply. Stagger power on is the delay time between switching on each output. The range is from 0.1 to 5 seconds. The default time is 1 second. To change the stagger power on time, select the “Timing” screen as described above then in the “Stagger Power On” pane press **Edit**. Type in the required time then press **Apply**.

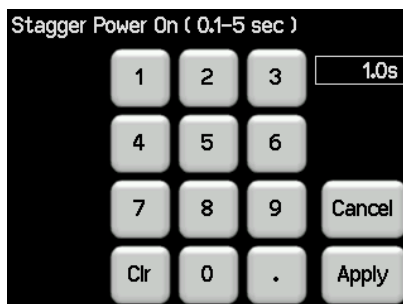

*Note: In Standalone mode, stagger time is fixed. See section 5.7.3*

### 5.11.2 Power Off Delay

Power off delay is the time that the outputs stay on when either DMX is lost or the GPI input contact closure is opened. The range is 0 (instant off) to 60 minutes or infinite. The default time is 5 minutes. To change the power off delay, select the “Timing” screen as described above then in the “Power Off Delay” pane press **Edit**. Type in the required time then press **Apply**.

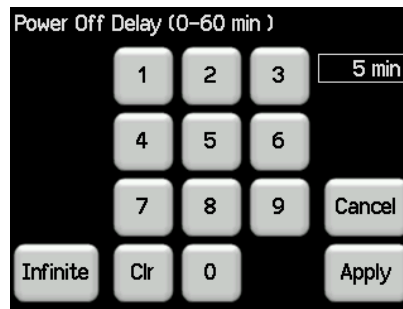

### 5.11.3 Warning Beep

If the DMX signal is lost or the GPI input contact closure is opened, the countdown to power off begins. When it reaches 1 minute a “warning beep” sounds (if enabled). When it reaches 30 seconds a warning appears on the screen and counts down the remaining time to switch off. The warning beep can be enabled or disabled from the “Timing Parameters” menu described above.

*Note:* APS units manufactured prior to March 2014 are not fitted with a beeper.

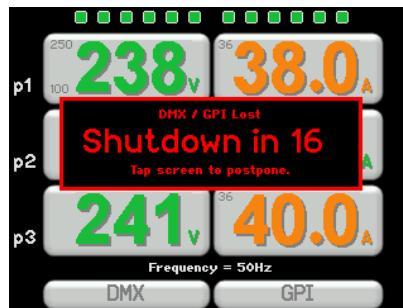

You can postpone the switch off and restart the countdown timer by tapping the screen. To disable the automatic switch off, set the “Power off delay” time to “Infinite”.

*Hint:* If the APS about to turn off and you want to keep it on, press the screen to postpone the shutdown then press anywhere on the **Home screen** then press **Stand Alone, Enable**.

### 5.12 Limits

Press anywhere on the **Home Screen** then press **Limits**.

The “Limits” menu allows you to set maximum (High) and minimum (Low) limits on the input voltage for each phase to protect the equipment connected to that phase. If these limits are exceeded, the input voltage display for that phase turns red and the outputs connected to that phase will be switched off and their status indicators also turn red.

When the input voltage returns to within the limits, the input voltage display turns green and the channel status indicators turn orange, but the outputs will remain off until the following conditions are met for each limit,

- High. The input voltage drops to 3 volts below the high limit for at least 10 seconds
- Low. The input voltage rises to 3 volts above the low limit for at least 10 seconds

The channels then automatically turn back on after their staggered start up time delay. Pressing **Limits** (in the Configuration menu) shows the limit settings for each phase.

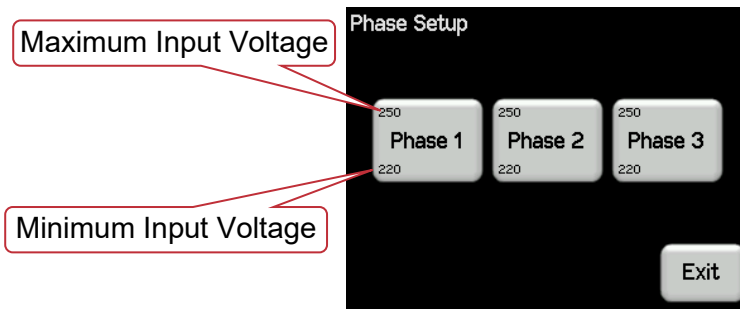

Pressing a **Phase** button allows you to select either the Low or High limit for that phase. These limits are also shown on the “Home” screen.

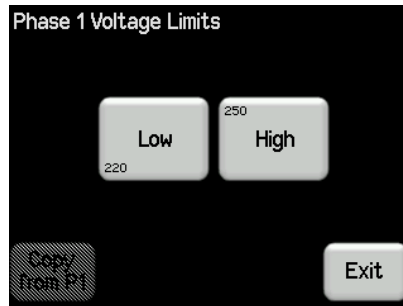

Pressing either **Low** or **High** allows you to set that limit.

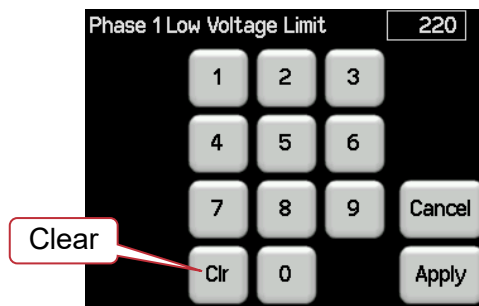

When phases 2 or 3 are selected, the settings for phase 1 can be copied to them by pressing **Copy from P1**.

The limits of each phase are also shown on the “Home” screen.

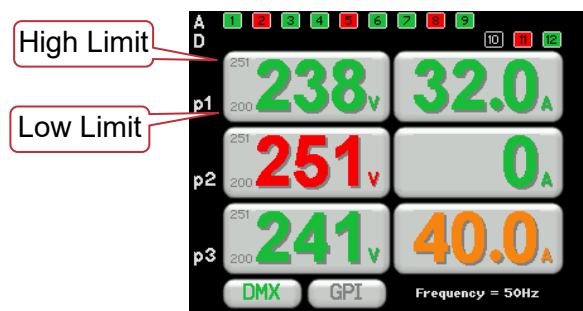

### 5.12.1 Removing Limits

To remove a limit on a phase press either **Low** or **High** then press **Clr** (Clear) then **Apply**.

### 5.12.2 Default Limits

If no limits have been set then a high limit of 270 volts still exists.

If any phase reaches 270 volts, then all outputs are turned off.

Normal operation is restored when the input voltage drops below 260 volts.

## 5.13 System

Touch anywhere on the **Home Screen** then press **System**. The “System” menu provides the following sub-menus,

- Code Upgrade
- Reset
- Colour Theme
- Import Export
- Service

### 5.13.1 Code (Software) Upgrade

LSC Control Systems has a corporate policy of continuous improvement to its products. The APS software (firmware) is subject to this policy as new features are added and existing features improved.

To see the current software version of your APS press anywhere on the **Home Screen** then press **About**.



To upgrade your APS software, download the latest version from the LSC web site.

[www.lsccontrol.com.au](http://www.lsccontrol.com.au)

As of 2021, APS units are manufactured using two possible types of controller module. Both types perform the same functions but require their own version of the operating software. The downloaded software is a ZIP file containing both versions. Double click on the ZIP file to automatically extract the two files then save both files to a SD card. The controller module in the APS knows which filename to look for so only the correct code will be loaded and upgraded.

Insert the SD card containing both files into the SD card socket on the APS. Press anywhere on the **Home Screen** then press **System, Code Upgrade**.

Software upgrades via RDM are now supported, but only on dimmers running Bootloader v2.05 or later (Ti only). See the HOUSTON X user manual section 5.2 for details on how to upgrade via RDM.

### 5.13.2 Reset

Press anywhere on the **Home Screen** then press **System, Reset**. There are two options:

#### 5.13.2.1 Restart

In the unlikely event that the APS fails to respond, the operating system may be restarted so that the software may initialise and recommence normal operation. Pressing **Restart** will not affect any of the settings or memory.

#### 5.13.2.2 Reset To Defaults

This will ERASE all memory from the APS and reset to defaults.

The default settings are:

- Set all channels to APS control
- Stagger power on = 1second

- Power off delay = 5 minutes
- Remove all phase voltage limits
- Disable “Stand Alone” mode
- Set to Manual Mode

### 5.13.3 Colour Theme

You can choose a colour theme for the touch screen.

Press anywhere on the **Home Screen** then press **System, Colour Theme**.

The choices are:

- Gothic (Default)
- Antarctic
- Dawn

### 5.13.4 Import Export

The configuration settings of an APS can be exported to a SD card allowing them to be imported and copied to other APS units. Insert an SD card into the front panel slot then press anywhere on the **Home Screen**, then **System, Import Export**, then follow the on-screen instructions.

### 5.13.5 Service

The Service menu is for factory use only.

## 5.14 About

To see the “About” menu, press anywhere on the **Home Screen** then **About**.

The “About” menu shows information about the software, capacity and owner of the APS.



### 5.14.1 Owner

**Warning:** *If you enter an owner name and or logo and press “Lock”, this is permanently locked and can only be changed by an authorised LSC dealer. You must set the name and logo before pushing Lock. Once Lock has been pressed, the name and logo cannot be changed without contacting the factory. This acts as a deterrent against theft of your APS.*

From the “About” menu, above, pressing **Owner** allows you to enter a permanent name for the APS (“This unit belongs to:”) and also allows you to set a “Logo” that will be momentarily displayed when power is applied to the APS (instead of the LSC logo).

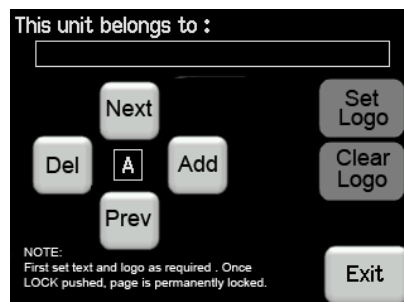

To enter an owner name, use the **Next** and **Prev** buttons to select a character then **Add** to enter the character or **Del** to delete a character.

To set a custom logo a special file must be present on an SD card inserted in the APS. There is a fee for LSC to convert your logo into the special file that will load into your APS. Please contact LSC or your LSC agent for details.

When the owner name and/or logo have been entered, the Exit button changes to “Lock”. To permanently lock in your changes, press **Lock**.

### 5.15 Lock / Unlock

To lock the touch screen and prevent unauthorised access, press anywhere on the **Home Screen**, then press the **Padlock** symbol.

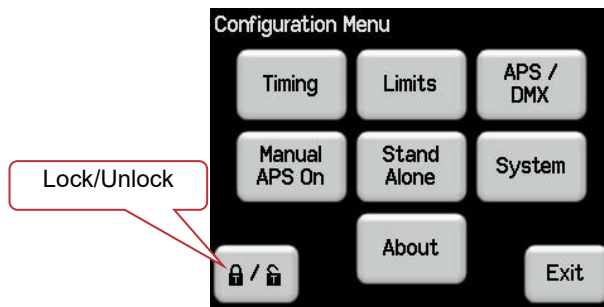

Pressing the **Padlock** symbol provides 2 levels of lock.

- **User.** Prevents all configuration changes.
- **Service.** This lock level is reserved for factory use only.

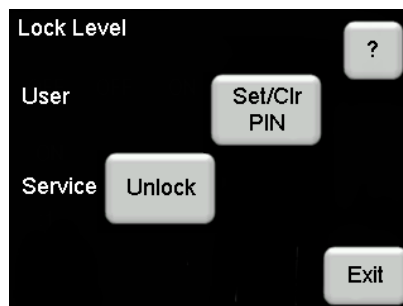

To set a PIN, press **Set/Clr PIN**. Enter a four-digit code. Entering 0000 clears the PIN.

If a PIN has been set, its “Lock” or “Unlock” button appears. Press **Lock** (or **Unlock**) to perform that task. You will be required to enter your PIN to unlock.

If a level has been locked, its “Set/Clr PIN” button is hidden.

## 6 RDM

### 6.1 Overview

RDM stands for **R**everse **D**evice **M**anagement. It is an “extension” to DMX.

Since the inception of DMX it has always been a ‘one way’ control system. Data only ever flows in one direction, from the lighting controller outwards to whatever it may be connected to. The controller has no idea what it is connected to, or even if what it's connected to is working, switched on, or even there at all!

RDM changes all that allowing the equipment to answer back and for you to remotely manage your device.

RDM has been designed to work with existing DMX systems. It does this by interleaving its messages with the regular DMX signal over the same wires. There is no need to change any of your cables but because RDM messages now go in two directions, any in-line DMX processing you have needs to be changed for new RDM hardware. This will most commonly mean that DMX splitters and buffers will need to be upgraded to RDM capable devices.

### 6.2 APS RDM Commands

APS provides the following functions over RDM:

- Over/Under voltage, over current and shutdown events are reported as “alarms.

<b>Global Commands:</b>	
Identify (Quiet)	Blinks a message on the screen.
ReStart/Reboot	
Get Device Name	
Get/Set Device Label	
Get Software version	
Get BootLoader version	
Get RDM ID	
Get DMX state (Sensor)	Presence of DMX
Get GPI state (Sensor)	
Get Fan Speed (Sensor)	
Get P1/P2/P3 state (Sensor)	Presence of input power phases
Get P1/P2/P3 voltage (Sensor)	
Get P1/P2/P3 current (Sensor)	
Get mains frequency (Sensor)	
Get channel state (Sensor)	
Get/Set Power State	Used to turn APS channels on/off. It replicates the [Manual APS On/Off] button.
<b>Sub-Devices (3, 6 or 12) Commands</b>	
Get/Set Device Label	

## 7 HOUSTON X

HOUSTON X is LSC's monitoring and remote configuration tool that works with LSC products such as APS, GEN VI, MDR-DIN, LED-CV4, UNITOUR, UNITY and Mantra Mini. HOUSTON X can be downloaded from the LSC website, [www.lsccontrol.com.au](http://www.lsccontrol.com.au)



HOUSTON X is the central overseer of your venue's equipment. The software runs on Windows and Mac computers. It gives you the absolute authority to interrogate, monitor and instantly change parameters of connected products.

Using HOUSTON X, you can quickly locate and isolate faults, monitor temperatures, phase loadings, change a channel from dimmer to power-switching mode (TruPower), save or recall show configurations, all from one central location or remotely via the internet.

Some LSC products have additional functionality enabled when licensed to operate with HOUSTON X.

## 8 Maintenance and Troubleshooting

**Warning.** No user controls or user serviceable parts are located inside the APS. Refer all servicing to suitably qualified personnel.

### 8.1 Maintenance

Ensure that the air vents at the side of the frame are free from obstruction and dust. Check that all connector screw terminals (if fitted) are tight. This must be performed by a suitably qualified person.



Check that the APS contains the latest software release.







### 8.2 Tripped Breakers

If a channel is not working check the MCB (Miniature Circuit Breaker) for that channel. If the MCB has tripped (OFF), firstly try to determine the cause of the breaker tripping. It could be a blown lamp or a circuit overload or and earth leakage fault. Remember that the touch screen shows the load current per phase, not per channel. Rectify to problem (replace the lamp or reduce the load) then restore the MCB. If the MCB continues to trip, refer the problem to a suitably qualified person.

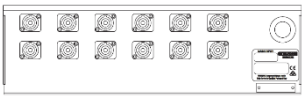
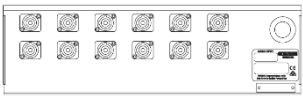
## 9 Specifications and Output Options

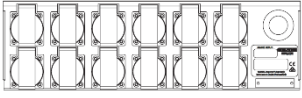
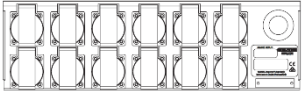
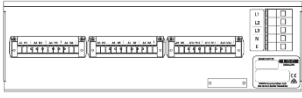
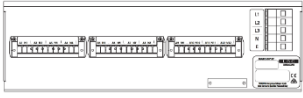
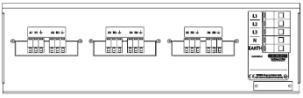
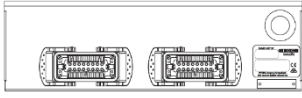
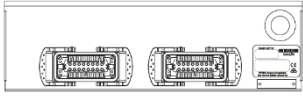
### 9.1 Rackmount APS

Rackmount Models	12 x 10A	12 x 16A Export Only	6 x 25A
<b>Control</b>	3.2" colour LCD with touch screen Programmable stand-alone mode via easy-to-use menus DMX512 (1990) or DMX512-A (E1-11) input with RDM (E1-20) functionality on 5-pin XLR connectors GPI voltage free contact closure on 5-pin XLR connectors (using pins 1+4)		
<b>Protection</b>	10A Residual Current Breaker (RCBO) per output channel	16A Residual Current Breaker (RCBO) per output channel	25A Residual Current Breaker (RCBO) per output channel
	30mA Earth leakage trip current per channel Dropped neutral protection with almost instant load disconnect Programmable channel sequential start-up time delay Cascading start-up between multiple units Programmable min and max voltage cut-off per phase		
<b>Monitoring</b>	3-phase voltage and current levels monitoring on main display Remote configuration and monitoring via RDM protocol Remote configuration and monitoring via LSC's HOUSTON X software		
<b>Power</b>	Nominal 100-240V, 3-phase star, 50-60Hz (single-phase operation possible, 63A maximum) Operating range typically 90-260V, 45-65Hz Hardwired models supplied with L1, L2, L3, N and E terminals for power connection. All other models as per below		
	Supplied with 1.2m long H07 rubber 5 core x 6mm <sup>2</sup> cable. (Export models supplied without connector, Australian models supplied with 32A 5-pin 3-phase plug fitted)	Supplied with 1.2m long H07 rubber 5 core x 10mm <sup>2</sup> cable no connector supplied. (Export only. Not available in Australia)	Supplied with 1.2m long H07 rubber 5 core x 6mm <sup>2</sup> cable. (Export models supplied without connector, Australian models supplied with 40A 5-pin 3-phase plug fitted)
<b>Mechanicals</b>	483mm (w) x 300mm (d) x 132mm (h) Weight: 11kg Full metal chassis with rear-screened polycarbonate labels Touch screen, DMX input, GPI input and RCBOs located on front panel Output connectors and power input cable located on rear panel		
<b>Peace of mind</b>	CE (European) and RCM (Australian) approved Two-year warranty Designed and manufactured in Australia by LSC, an Australian owned company with over 40 years' experience in developing world-first product		
<b>Outputs</b>	APS12/10A  12 x 3-pin 10 Amp Australian sockets		APS6/25A  6 paired 3-pin 20Amp/15Amp Australian sockets

<b>Rackmount Models</b>	<b>12 x 10A</b>	<b>12 x 16A Export Only</b>	<b>6 x 25A</b>
	<p>APS12/10P</p>  <p>powerCon</p>	<p>APS12/16P</p>  <p>powerCon</p>	
	<p>APS12/10PT1</p>  <p>powerCon True1Top</p>	<p>APS12/16PT1</p>  <p>powerCon True1Top</p>	
	<p>APS12/10S</p>  <p>CEE7</p>	<p>APS12/16S</p>  <p>CEE7 (Schuko)</p>	
	<p>APS12/10T</p>  <p>Hardwired terminals</p>	<p>APS16/10T</p>  <p>Hardwired terminals</p>	<p>PWP6/25T</p>  <p>Hardwired terminals</p>
	<p>APS12/10W</p>  <p>2 x 16-pin Wieland</p>	<p>APS12/16W</p>  <p>2 x 16-pin Wieland</p>	
	<p>APS12/10X</p>  <p>2 x 19-pin Socapex</p>	<p>APS12/16X</p>  <p>2 x 19-pin Socapex</p>	
	<p>APS12/10XPT1</p>  <p>2 x 19-pin Socapex plus 3 powerCon True1Top in parallel with channels 1-3 of the Socapex</p>	<p>APS12/16XPT1</p>  <p>2 x 19-pin Socapex plus 3 powerCon True1Top in parallel with channels 1-3 of the Socapex</p>	

## 9.2 Wallmount APS

<b>Wallmount Models</b>	<b>12 x 10A</b>	<b>6 x 25A</b>
<b>Control</b>	<p>3.2" colour LCD with touch screen                      Programmable stand-alone mode via easy-to-use menus                      DMX512 (1990) or DMX512-A (E1-11) input with RDM (E1-20) functionality on 5-pin XLR connectors                      GPI voltage free contact closure on 5-pin XLR connectors (using pins 1+4)</p>	
<b>Protection</b>	<p>12 channel x 10A RCBO breakers with 30mA trip per channel</p>	<p>6 channel x 25A RCBO breakers with 30mA trip per channel</p>

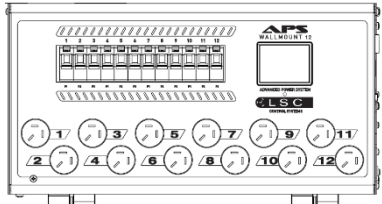
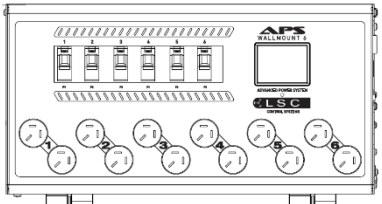
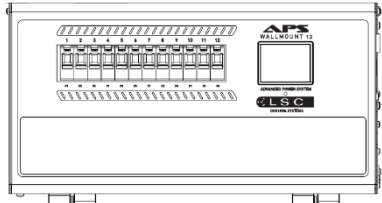
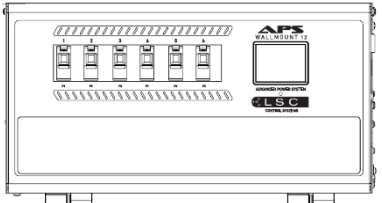
	<p>Dropped neutral protection with almost instant load disconnect</p> <p>Programmable channel sequential start-up time delay</p> <p>Cascading start-up between multiple units</p> <p>Programmable min and max voltage cut-off per phase</p>	
<b>Wallmount Models</b>	<b>12 x 10A</b>	<b>6 x 25A</b>
<b>Monitoring</b>	<p>3-phase voltage and current levels monitoring on main display</p> <p>Remote configuration and monitoring via RDM protocol</p> <p>Remote configuration and monitoring via LSC's HOUSTON X software</p>	
<b>Power</b>	<p>Nominal 100-240V, 3-phase star, 50-60Hz (single-phase operation possible, 63A maximum)</p> <p>Operating range typically 90-260V, 45-65Hz</p> <p>All models supplied with L1, L2, L3, N, and E terminals for power connection</p>	
<b>Mechanicals</b>	<p>490mm (w) x 270mm (d) x 250mm (h)</p> <p>Weight: 16kg</p> <p>Full metal two-part hinged chassis with rear-screened polycarbonate labels</p> <p>Touch screen, dimmer output connectors, RCBOs located on front panel</p> <p>DMX input and GPI input located on right side panel</p> <p>Input power terminals housed internally, optional cable gland to allow flying tail to be connected</p>	
<b>Peace of Mind</b>	<p>CE (European) and RCM (Australian) approved</p> <p>Two-year warranty</p> <p>Designed and manufactured in Australia by LSC, an Australian-owned company with over 40 years' experience in developing world-first products</p>	
<b>Outputs</b>	<p><b>APW12/10A</b></p>  <p>12 x 3-pin 10 Amp Australian sockets</p>	<p><b>APW6/25A</b></p>  <p>6 paired 3-pin 20Amp/15Amp Australian sockets</p>
	<p><b>APW12/10T</b></p>  <p>Hardwired internal terminals</p>	<p><b>APW6/25T</b></p>  <p>Hardwired internal terminals</p>

### 9.3 Wieland Pinouts

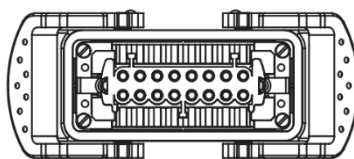

**WARNING.** Several wiring standards exist for the pin outs of Wieland multipin sockets. If in doubt, a suitably qualified person should check that your Wieland cables are wired to the same standard as your APS.

Note: Earth connection is via the clips on the side of the socket insert.

### 9.4 Socapex Pinouts

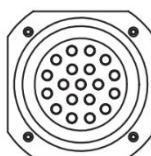

Connector #1	Function	Connector #2	Function
Pin 1	Chan 1 Active	Pin 1	Chan 7 Active
Pin 2	Chan 1 Neutral	Pin 2	Chan 7 Neutral
Pin 3	Chan 2 Active	Pin 3	Chan 8 Active
Pin 4	Chan 2 Neutral	Pin 4	Chan 8 Neutral
Pin 5	Chan 3 Active	Pin 5	Chan 9 Active
Pin 6	Chan 3 Neutral	Pin 6	Chan 9 Neutral
Pin 7	Chan 4 Active	Pin 7	Chan 10 Active
Pin 8	Chan 4 Neutral	Pin 8	Chan 10 Neutral
Pin 9	Chan 5 Active	Pin 9	Chan 11 Active
Pin 10	Chan 5 Neutral	Pin 10	Chan 11 Neutral
Pin 11	Chan 6 Active	Pin 11	Chan 12 Active
Pin 12	Chan 6 Neutral	Pin 12	Chan 12 Neutral
Pin 13	Earth	Pin 13	Earth
Pin 14	Earth	Pin 14	Earth
Pin 15	Earth	Pin 15	Earth
Pin 16	Earth	Pin 16	Earth
Pin 17	Earth	Pin 17	Earth
Pin 18	Earth	Pin 18	Earth
Pin 19	Earth	Pin 19	Earth

## 10 Feature History

The new features added to APS in each software release are listed below:

Release: v4.03 Date: 11-Aug-2023

- It is now possible to set the Lock code independently of the Lock function
- Software upgrades via RDM are now supported, but only on units running Bootloader v2.05 or later (Ti only)
- Buzzer and fan test added to service menu

Release: v4.02 Date: 30-Aug-2022

- The Owners Name can now accept numeric characters
- Fan speed now set to a minimum of 30%

Release: v4.01 Date: 3-December-2021

- Unified Code: Due to our policy of continual product improvements, the APS now has a new CPU card based on the Ti family of microprocessors. The new CPU card requires different software to the original NXP based cards. This is the first version of APS software that is available for both CPU variants and has all software features and GUI updates implemented in both versions. The unified code is based on our new v4 platform, hence the major version number jump from 3.xx to 4.xx. Some bug fixes apply to both CPU types and others are specific to one CPU type only, this is notated by the CPU type in brackets (eg. Ti + NXP).
- The unit now fully supports Houston X (Ti + NXP).
- The new CPU card now supports firmware upgrades via Houston X (Ti).
- The access levels for the menu system have been overhauled. The User and Owner Login levels are now redundant and have therefore been removed from the Login screen (Ti + NXP)

Release: v3.10 Date: 19-June-2020

- The fan is now controlled by total load on unit. Fans will go to full speed when the unit is fully loaded to 16A per channel for more than 60 seconds. Total Load is calculated once every second and the average taken over the last 60 seconds and then converted to a percentage of full load and this value is applied to the fans.
- RDM has been improved and enhanced to operate with HOUSTON X.
- Unit now powers up in Manual Mode by default.
- A user logo can now be uploaded to the APS, as per the GEN VI Dimmer

Release: v3.0 Date: 22-May-2018

- The timing of circuit switching has been changed to further minimise inrush current
- The minimum timeout for lost DMX or contact closures has been changed to include zero
- When updating code, the SD card is first checked for a valid file and a button now allows the user to choose whether to update or not
- Channel OFF and channel ON functionality has been added. It is now possible to park a channel in either the OFF or ON state. All control of the channel is ignored except that any ON channels will still turn off if the supply volts are outside the set limits

Release: v2.0 Date: 01-Sep-2016

- Each output circuit can now be controlled by a DMX slot directly. This is the equivalent of a DMX controlled switch. APS units with earlier software can be easily upgraded to take advantage of this feature

Release: v1.02 Date: 18-Mar-2014

- Fan Speed Control implemented
- If enabled, beeper sounds whenever shutdown warning is active. Enabled by default
- Power Off delay can now be set to infinite

Release: v1.00 Date: 29-Oct-2013

- First public release

## 11 Compliance Statements

The APS from LSC Control Systems Pty Ltd meets all required CE (European), RCM (Australian) and UKCA (United Kingdom) standards.

*CENELEC (European Committee for Electrotechnical Standardization).*



*Australian RCM (Regulatory Compliance Mark).*



**WEEE** (*Waste Electrical and Electronic Equipment*).



The WEEE symbol indicates that the product should not be discarded as unsorted waste but must be sent to separate collection facilities for recovery and recycling.



For more information about how to recycle your LSC product, contact the dealer where you purchased the product or contact LSC via email at [info@lsccontrol.com.au](mailto:info@lsccontrol.com.au)

You can also take any old electrical equipment to participating civic amenity sites (often known as 'household waste recycling centres') run by local councils. You can locate your closest participating recycling centre using the following links.

- AUSTRALIA <http://www.dropzone.org.au>.
- NEW ZEALAND <http://ewaste.org.nz/welcome/main>
- NORTH AMERICA <http://1800recycling.com>
- UK [www.recycle-more.co.uk](http://www.recycle-more.co.uk).

# APS

-END-