

DATAFLASH[®]

●●:::AF1000:::●●

Xenon Strobe

User's Manual

Please read all cautions and warnings inside.



HIGH END SYSTEMS[®]



2105 Gracy Farms Lane
Austin, Texas 78758

Declaration of Conformity

according to ISO/IEC Guide 22 and EN45104

Manufacturer's name: High End Systems
Manufacturer's address: 2105 Gracy Farms Lane
Austin, Texas 78758
U.S.A.

Distributor's name: High End Systems
Distributor's name: 2105 Gracy Farms Lane
Austin, Texas 78758
U.S.A.

declares that the product

Product Name: AF1000

Product Number: Dataflash AF1000

Product Options: All

conforms to the following EEC directives:

73/23/EEC, as amended by 93/68/EEC

89/336/EEC, as amended by 92/31/EEC and 93/68/EEC

Equipment referred to in this declaration of conformity first manufactured in 1995 in compliance with the following standards:

Safety: EN 60598-1 : 1993
EN 60598-2-17 : 1989
A1-A3 : 1993

EMC: EN 55022 Class A ITE
IEC 801-2 Level 2 (4/8 kV)
IEC 801-3 Level 2 (3 V/m)
IEC 801-4 Level 2 (1/.5 kV)



U.S.A., Thursday, September 24, 1998
Kenneth Hansen, Compliance Engineer

IMPORTANT SAFETY INFORMATION

INSTRUCTIONS PERTAINING TO CONTINUED PROTECTION AGAINST FIRE, ELECTRIC SHOCK, EXPOSURE TO EXCESSIVE UV RADIATION, AND INJURY TO PERSONS ARE FOUND IN APPENDIX D.

READ ALL CAUTIONS AND WARNINGS PRIOR TO ASSEMBLY, MOUNTING, AND OPERATING THIS EQUIPMENT.

IMPORTANT: INFORMATIONS DE SÉCURITÉ

INSTRUCTIONS RELATIVES À UNE PROTECTION CONTINUE CONTRE L' INCENDIE, LE CHOC ÉLECTRIQUE, L' EXPOSITION AUX RADIATIONS ULTRAVIOLETTES EXCESSIVES ET CONTRE DES BLESSURES POSSIBLES SUR DES INDIVIDUS SE TROUVENT DANS L'APPENDICE D.

PRIÈRE DE LIRE TOUTES LES PRÉCAUTIONS ET LES AVERTISSEMENTS AVANT D'ASSEMBLER, DE MONTER, ET DE FAIRE FONCTIONNER CET ÉQUIPEMENT.

WICHTIGE SICHERHEITSHINWEISE

DIE NACHSTEHENDEN HINWEISE BETREFFEN DEN SCHUTZ GEGEN BRAND, ELEKTRISCHEN SCHLAG, ÜBERHÖHTE UV-STRAHLUNG SOWIE VERLETZUNGEN. SIE BEFINDEN SICH IN APPENDIX D.

LESEN SIE ALLE WARNUNGEN SORGFÄLTIG, BEVOR SIE DAS GERÄT ZUSAMMENBAUEN, INSTALLIEREN UND BENUTZEN!

INFORMACIÓN IMPORTANTE DE SEGURIDAD

SE ENCUENTRAN EN EL APÉNDICE D LAS INSTRUCCIONES CONCERNIENTES A LA PROTECCIÓN CONTINUA CONTRA INCENDIO, CHOQUE ELÉCTRICO, EXPOSICIÓN EXCESIVA A RAYOS ULTRAVIOLETAS Y LESIONES A PERSONAS.

POR FAVOR LEA TODAS LAS PRECAUCIONES Y LAS ADVERTENCIAS ANTES DE ENSAMBLAR, MONTAR Y OPERAR ESTE EQUIPO.

INFORMAZIONI IMPORTANTI DI SICUREZZA

ISTRUZIONI PERTINENTI LA PROTEZIONE CONTRO IL FUOCO, LE SCOSSE ELETTRICHE, L' ECCESSIVA ESPOSIZIONE AI RAGGI ULTRAVIOLETTI I DANNI ALLE PERSONE SI TROVANO NEL APPENDICE D.

LEGGERE TUTTI GLI AVVERMENTI PRIMA DI MONTARE E USARE QUESTO APPARECCHIO.

Trademarks used in this text: the *Dataflash*, *High End Systems*, *Lightwave Research*, *Lithopatterns*, and *Status Cue* are registered trademarks of High End Systems, Inc.; *GE* is a registered trademark of General Electric.

Dataflash AF1000 uses one or more of the following patents: US 4,962,687; US 5,078,039; UK 2,043,769; US 5,331,822; US 5,402,326; UK 2292896; US D365165; US 5,430,629; US D360,404; US 5,455,748; 0475082; US 5,506,762; M9604224.9; US 5,515,254; US D370080; UK 2.291.814; US 5,545.951; UK 2055842; UK 2,292,530; UK 2294909; UK 2292896; 1052/96; 862-1996; and US 5,580,164.

Other patents may be pending.

Warranty Information

Limited Warranty

Unless otherwise stated, your product is covered by a two year parts and labor limited warranty. Dichroic filters and Lithopatterns® are not guaranteed against breakage or scratches to coating. It is the owner's responsibility to furnish receipts or invoices for verification of purchase, date, and dealer or distributor. If purchase date cannot be provided, date of manufacture will be used to determine warranty period.

Returning an Item Under Warranty for Repair

It is necessary to obtain a Return Authorization Number (RA#) from your dealer/point of purchase BEFORE any units are returned for repair. The manufacturer will make the final determination as to whether or not the unit is covered by warranty. Lamps are covered by the lamp manufacturer's warranty.

Any Product unit or parts returned to High End Systems must be packaged in a suitable manner to ensure the protection of such Product unit or parts, and such package shall be clearly and prominently marked to indicate that the package contains returned Product units or parts and with a Returned Authorization (RA#) number. Accompany all returned Product units or parts with a written explanation of the alleged problem or malfunction.

Please note: Freight Damage Claims are invalid for fixtures shipped in non-factory boxes and packing materials.

Freight

All shipping will be paid by the purchaser. Items under warranty shall have return shipping paid by the manufacturer only in the Continental United States. Under no circumstances will freight collect shipments be accepted. Prepaid shipping does not include rush expediting such as airfreight. Airfreight can be sent customer collect in the Continental United States.

REPAIR OR REPLACEMENT AS PROVIDED FOR UNDER THIS WARRANTY IS THE EXCLUSIVE REMEDY OF THE CONSUMER. HIGH END SYSTEMS, INC. MAKES NO WARRANTIES, EXPRESSED OR IMPLIED, WITH RESPECT TO ANY PRODUCT, AND HIGH END SPECIFICALLY DISCLAIMS ANY WARRANTY OF MERCHANTABILITY OR FITNESS FOR A PARTICULAR PURPOSE. HIGH END SHALL NOT BE LIABLE FOR ANY INDIRECT, INCIDENTAL, OR CONSEQUENTIAL DAMAGE, INCLUDING LOST PROFITS, SUSTAINED OR INCURRED IN CONNECTION WITH ANY PRODUCT OR CAUSED BY PRODUCT DEFECTS OR THE PARTIAL OR TOTAL FAILURE OF ANY PRODUCT REGARDLESS OF THE FORM OF ACTION, WHETHER IN CONTRACT, TORT, (INCLUDING NEGLIGENCE), STRICT LIABILITY, OR OTHERWISE, AND WHETHER OR NOT SUCH DAMAGE WAS FORESEEN OR UNFORESEEN.

Warranty is void if the product is misused, damaged, modified in any way, or for unauthorized repairs or parts. This warranty gives you specific legal rights, and you may also have other rights which vary from state to state.

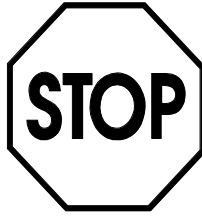

Helpful Information For Fixture Setup And Addressing

AF1000 fixtures are shipped with Personality DIP switch #2 in the “on” position. This is Self-Test Mode and it must be turned off before the fixture is used for any other application.

If you are using the Lightwave Research® AF1000 LCD Controller or the Mini Controller for the AF1000, Personality DIP switches #3 and #4 must be set to “on.” This is two channel mode.

Unlike the original Dataflash®, the Dataflash AF1000 has an added Duration¹ component. When used properly, Duration is an exciting effect. However, take care when programming fixtures as Duration will reduce Duty Cycle².

DMX start channels should be set every one, two, or three channels depending upon configuration. Refer to the following table for an example:

Two Channel Mode Example

Fixture Number	Address Switches On
1	None
2	2
3	3
4	2-3

¹**Duration**- length of time the lamp is actually illuminated per flash.
Note: longer durations create higher energy in the lamp which cause the fixture to go into cool down faster.

²**Duty Cycle**- length of time before the fixture goes into cool down.
Note: at lower flash rates, Duty Cycle can be infinite.

Table of Contents

Introduction	1
Cautions and Warnings	1
Instant Operation-Self Test	1
Dataflash AF1000 Features	2
Fixture Specifications	2
Safety and EMC Standards	3
Available Controllers	4
Accessories	4
Understanding the AF1000	5
Duty Cycle	5
Intensity	5
Duty Cycle Versus Intensity Modes	6
Rate	6
Duration	6
LED Indicators	7
Power Requirements	7
Line Cord Cap Assembly	8
Data Cable Construction	9
Indoor Cables	9
Outdoor Cables	9
Indoor Installation Instructions	10
Weatherized Installation Instructions	12
Modes of Operation	14
Self-Test Mode	14
Stand-Alone Mode	15
DMX Mode	16
DMX-512 Starting Channel	17
Controlling AF1000 with DMX	18
Intensity Mode Configuration	19
Troubleshooting	20
Getting Help	21
Appendix A Axial Reflector Installation	21
Appendix B Horizontal Reflector Installation	22
Appendix C DIP Switch Settings for DMX-512 Starting Channel	23
Appendix D Important Safety Information	28
Annexe D Informations Importantes Concernant La Sécurité	29
Anhang D Wichtige Hinweise für Ihre Sicherheit	30
Apéndice D Información Importante Sobre La Seguridad	32

Appendice D Informazioni Importanti Per La Sicurezza	33
Appendiks D Vigtig Fikker Heds Information	34
Appendix E FCC Information	34

List of Figures

AF1000 Lamps	3
Duty Cycle Versus Intensity Modes	6
Duration Example	6
LED Indicators	7
Wiring Color Code	8
Data Cable Construction	9
Yoke Attachment	11
Mounting the Fixture	11
Yoke Attachment	12
Mounting the Fixture	13
Self-Test Mode	14
DMX Addressing	17
Daisy Chaining Fixtures	17
Axial Reflector Installation	21
Horizontal Reflector Installation	22

List of Tables

Power Requirements	7
Stand Alone Mode	15
DMX Personality Switch Settings	16
AF1000 DMX Settings	18
Intensity Mode Configuration	19
Troubleshooting	20
DIP Switch Settings for DMX-512 Starting Channel	23

Introduction

Congratulations on your purchase of the Dataflash® AF1000 Xenon Strobe Fixture. You now have at your disposal, one of the most advanced xenon flash lamp systems in the world. Multiple fixtures, each individually addressable and dimmable, provide bursts of incredible pyrotechnics power or soft hues for more subtle effects. Add to this the flexibility of a weatherized version suitable for outdoor applications, two choices of lamps, three intensity/duty cycle modes, and you have the most versatile xenon flash lamp system in the world. Colored domes, axial and horizontal reflectors, and dichroic filters are available options. Each fixture can be run independently in a stand alone mode, or daisy chain multiple fixtures for DMX-512 control.

Cautions and Warnings

Due to its incredible power, it is extremely important that you read this entire manual before operating this fixture. Refer to “Understanding the AF1000” on page 5 before mounting fixtures. Please be sure you read and understand all warnings and cautions in this manual. Additional safety information is contained in Appendix D. For safety purposes, the fixture dome and the jacket of the HO-1 bulb are ultraviolet screens.

The following international symbols appear in margins throughout this manual to highlight caution and warning messages:



Caution: This symbol appears adjacent to Caution messages. Ignoring these messages could result damage to equipment or data loss.



Warning: This symbol appears adjacent to High Voltage Warning messages. Ignoring these messages could result in serious personal injury.

Instant Operation-Self Test

If you would like to see what an AF1000 is capable of, follow the instructions under “Line Cord Cap Assembly” on page 8 and “Indoor Installation Instructions” on page 10 or “Weatherized Installation Instructions” on page 12, but do not change any DIP switch settings. The fixture is shipped in Self-Test Mode and will run through a demonstration test pattern when power is supplied.

Dataflash AF1000 Features

- Auto-voltage and frequency sensing from 90 V-255 V 50/60 Hz
- Controllable via USITT DMX-512
- Up to 512 fixtures may be independently addressed
- Seven DMX modes
- Stand alone mode
- 25,000 Joules maximum continuous flash power
- Maximum flash rate 120 flashes per second (FPS) at 60 Hz and 100 FPS at 50 Hz
- 64 levels of intensity (dimming)
- 64 levels of rate
- 64 levels of duration
- Microprocessor-regulated duty cycle
- Self-resetting thermal shutdown
- Three-phase system capability
- Weatherized (IP54 rated) and indoor versions
- Data active, status, and power LEDs providing the user access to the fixture's built-in self-diagnostic facility
- 8000 Kelvin color temperature
- Quick and easy lamp replacement

Fixture Specifications

Models

- AF1000 Indoor (dry locations only)
- AF1000 Weatherized (rated IP54)

Electrical

Maximum flash rate:	120 flashes/second on 60 Hz line 100 flashes/second on 50 Hz line
Minimum flash rate:	dependent upon DMX refresh rate
Maximum duty cycle:	∞ (depending on mode, intensity, rate, and duration)
Maximum flash energy:	100 joules per 1/2 cycle flash
Maximum continuous flash energy:	25,000 joules
Rated voltage:	100-230 VAC Only
Rated current:	27 A peak, 6 A continuous for 2 minute duty cycle
Rated power:	1650 W Pulse Controlled Average
Rated frequency:	50-60 Hz
Max. ambient temperature, Ta:	50° C (122° F)
Max. exterior surface temperature:	70° C (158° F)
Minimum distance to lighted object:	1.0 meter (3.28 feet)
Power factor:	115 V 60 Hz = .98, 230 V 50 Hz = .96
Max. winding temperature, Tw:	130° C (266° F)
Max. capacitor temperature, Tc:	85° C (185° F)

Mechanical

Housing dimensions:	213 mm (8.38") dia. x 101mm (4.0") deep
Dome:	211 mm (8.32") dia. x 138.5 mm (5.5") deep
Yoke:	3.17 mm (0.125") aluminum
Net Weight:	1.77 Kg (3.9 lbs.)

Lamps

Lamp type: Use only HO1 or SO1 Xenon Flashtube

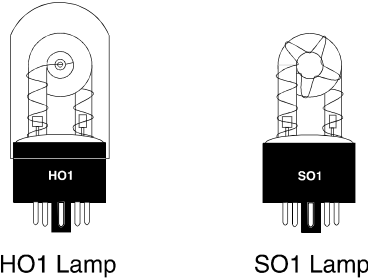

Figure 1. AF1000 Lamps

Lamp color temperature:	8000 Kelvin
Lamp life:	
-Standard Mode:	Two million flashes @30 Joules (SO1)
-Architectural Mode:	Eight million flashes @ 30 Joules (HO1)
-Special Effect Mode:	Four million flashes @ 60 Joules (HO1)

Safety and EMC Standards

The Dataflash AF1000 strobe fixture is compliant with the following standards:

- UL 1573
- CSA 22.2 Number 166
- EN 55022 Class A
- EN 60598-1 : 1993
- EN 60598-2-17 : 1989 A1-A3 : 1993
- IEC 801-2 Level 2 (4/8 kV)
- IEC 801-3 Level 2 (3 V/m)
- IEC 801-4 Level 2 (1/.5 kV)
- FCC- Class A digital device, Part 15 (refer to Appendix E)



Available Controllers

The following controllers from Lightwave Research® may be used to operate AF1000 fixtures:

Item	Part Number
Status Cue® Lighting Controller	22020002
LCD Controller for Dataflash AF1000	21020006
Mini Controller for Dataflash AF1000	21020004

Additionally, any DMX-512 controller may be used to operate AF1000 fixtures.

Accessories

Item	Part Number
Axial reflector	21040001
Horizontal reflector	21040002
HO-I high-power lamp	55030042
SO-I standard lamp	55030038
Clear dome	80130019
Red dome	21040003
Blue dome	21040004
Green dome	21040005
Violet dome	21040006
Weather resistant male XLR connector	90404035
Weather resistant female XLR connector	90404036
Serial data distributor (1 in/6 out/1 through)	55040001
10-foot heavy duty data cable w/ Neutrik XLRs	55050005
25-foot heavy duty data cable w/ Neutrik XLRs	55050006
50-foot heavy duty data cable w/ Neutrik XLRs	55050007
100-foot heavy duty data cable w/ Neutrik XLRs	55050008
Keal road case for 16 fixtures and one LCD controller)	03070001
Deluxe C-clamp w/silver vein powder coat finish	55000004
Galvanized safety cable w/spring snap	12040001
Winflash Software Application	80440020



Understanding the AF1000

If you want your AF1000 to flash for more than a brief period of time, read the following important information. It is imperative that you understand the information in this section before installing or configuring any AF1000 fixtures.

Duty Cycle

Duty cycle is the how the AF1000 protects the lamp from overheating. With each flash of the lamp, the internal circuitry of each fixture calculates how much energy is released. When a specific amount of energy is released within a certain time, the fixture goes into a cool down period. Higher intensities, rates, and durations can mean shorter duty cycles. Lower intensities, rates, and durations mean longer duty cycles. Cool down lasts 2 minutes in Standard Mode, 5 minutes in Architectural Mode, and 5 minutes in Special Effect Mode. When cool down is over, the fixture rejoins whatever program is playing at the current position of playback. Plan ahead and experiment with duty cycle so you can avoid interruptions from cool down.

Intensity

Intensity is the light output (brightness) of the fixture. Intensity is linearly scaled with 64 steps available (0=off and 63=maximum). There are three intensity modes available:

- Standard Mode– the default setting when neither architectural or special effect are selected. The intensities and duty cycles are almost identical to the original Dataflash. This is the only setting where use of the SOI lamp is allowed.
- Architectural Mode– this setting has a standard intensity, but allows for longer duty cycles using the HOI lamp.
- Special Effect Mode– possible only with voltages of 190 and above. If you try to use Special Effect at voltages less than 190 VAC 50/60 Hz, it will default to Architectural Mode. This setting allows the highest intensity light bursts. The duty cycle has been adjusted to allow for these bursts.



WARNING: Use Only The HOI Lamp With Architectural And Special Effect Modes.

Duty Cycle Versus Intensity Modes

The duty cycle of the three intensity modes are different. At full intensity (10 fps), Architectural Mode provides three times the duty cycle of the Standard Mode, while Special Effect Mode provides nearly twice the duty cycle. Refer to Figure 2.

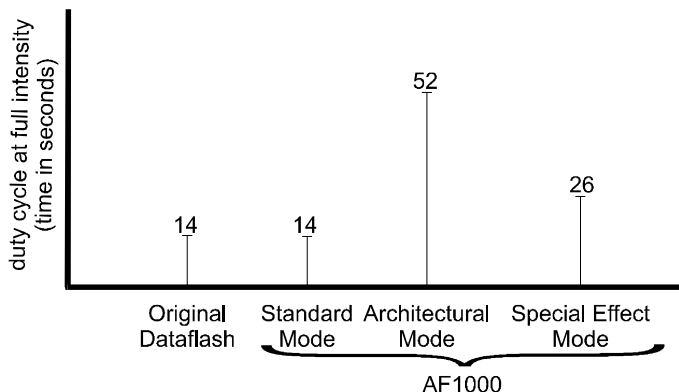

Figure 2. Duty Cycle Versus Intensity Modes

Rate

Rate is the number of times the lamp flashes per second. An AF1000 can flash once every $\frac{1}{2}$ cycle of the line frequency, thus it can flash 120 times per second with a 60-Hz line and 100 times per second with a 50-Hz line. Rate is linearly scaled into 64 incremental steps. It is important to note the heat caused by high rates can reduce duty cycle. If rate is used with moderate intensities and durations, duty cycle can be infinite.

Duration

Duration is the time the lamp is actually on (lit). Duration is a multiplier of the $\frac{1}{2}$ cycle flashes. It is also linearly scaled with 64 incremental steps available. Duration can be as short as .008 seconds on a 60-Hz line (.01 seconds on a 50 Hz line) or infinite (intensity dependent). Infinite durations can be accomplished by using rate and Intensity sparingly. If a duration of 32 is given to the fixture, the lamp would remain on for 0.266 seconds on a 60-Hz line and 0.32 seconds on a 50-Hz line. This concept is illustrated in Figure 3.

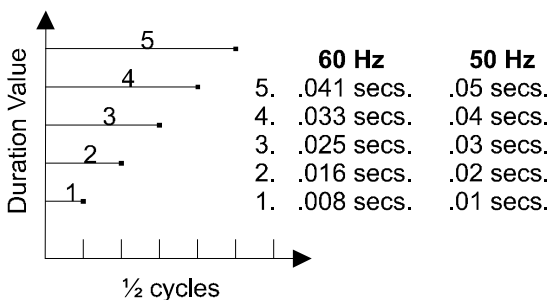

Figure 3. Duration Example

LED Indicators

The LED Indicators are located on the base inside the dome. They indicate the following:

Power - indicates the logic system is powered

Status - off—no DMX data being received or fixture time out
on steady—ready for operation

2 Hz flash—cool down initiated by processor

4 Hz flash—cool down initiated by thermal switch in base plate

Data - flashes with each packet of DMX data received from the link

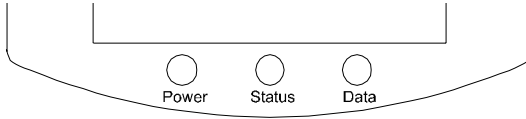

Figure 4. LED Indicators

Power Requirements

The following items must be used to provide power to the fixtures:

- Minimum of 12 AWG stranded THHN or equivalent.
- 20 A Branch Circuit Protection, high-surge thermal breaker (GE® THQB, THQL or equivalent). Do not use magnetic type circuit breakers.
- For weatherized AF1000s, an approved liquid-tight cable seal mounted to a suitable junction box per local electric codes.

We recommend the following configurations based on operational modes and voltages:

Table 1: Power Requirements

Operational Mode	Number of Fixtures per 20 A Breaker	Required Voltage
Standard	3	90–255 VAC
Architectural	2	90–255 VAC
Special Effect	1	190–255 VAC

Line Cord Cap Assembly

The AF1000 fixture is shipped without a line cord cap attached. Secure the line cord to a line cord cap in accordance with the following code:

- green and yellow—earth
- blue—neutral
- brown—live

Color code information is shown in Figure 5. Weatherized AF1000s require an approved liquid-tight cable seal mounted to a suitable junction box per local electric codes.

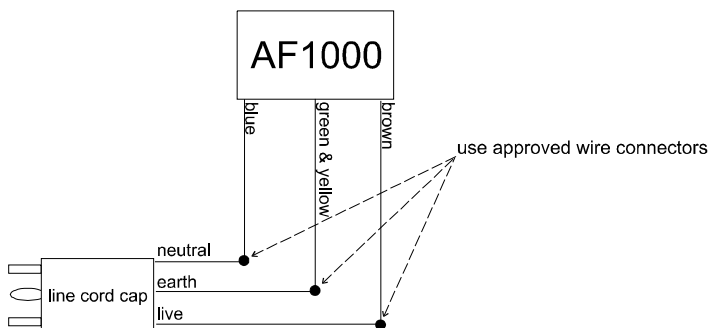

Figure 5. Wiring Color Code

In the United States, use an integral cord grip that is rated either at 125 V 20 A (NEMA 5-20) or 250 V 20 A (NEMA 6-20), depending on the available supply.

In the United Kingdom, as the colours of the cores in the mains lead of this equipment may not correspond with the coloured markings identifying the terminals in your plug, proceed as follows:

- the core which is coloured green and yellow must be connected to the terminal in the plug which is marked with the letter **E** or by the earth symbol \oplus or coloured green or green and yellow.
- the core which is coloured blue must be connected to the terminal which is marked with the letter **N** or coloured black.
- the core which is coloured brown must be connected to the terminal which is marked with the letter **L** or coloured red.



WARNING: Class I equipment. This equipment must be earthed.

Data Cable Construction

Indoor Cables

The Data In and Data Out XLR connections used for DMX control of the AF1000 are located on the back of the fixture. The AF1000 uses standard 3-pin XLR connectors. You should construct data cables using shielded, two conductor cable with male 3-pin XLR connectors at one end and a female 3-pin XLR connectors on the other end. You can use the cable specifications in “Outdoor Cables” or microphone cables if the pin connections are correct. Test each cable with a volt-ohm meter for correct polarity and ensure that the negative and positive pins are not grounded or shorted to the shield. Ensure that pin 1 is shielded. Refer to Figure 6.

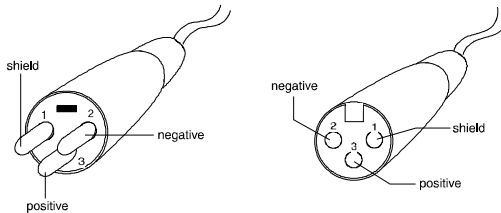

Figure 6. Data Cable Construction

Outdoor Cables

Follow the instructions outlined above in “Indoor Cables” for cable construction. Use outdoor approved data cables meeting the following requirements:

- 2-conductor twisted pair plus a shield with drain wire
- maximum capacitance between conductors - 30 pF/ft.
- maximum capacitance between conductor and shield - 55 pF/ft.
- maximum resistance of 20 Ω /1000 ft.
- nominal impedance 100–140 Ω
- 22–24 AWG with insulation having a dielectric rating of 300 volts or higher
- supplied water-resistant connectors provided with the fixture

An example of a wire that meets the above requirements is IPC[®] AWM2101.

Indoor Installation Instructions

Each indoor model is shipped with the following:

- Fixture base
- Dome
- Yoke
- 2 T-handles
- 2 rubber washers
- Silicone O-ring

You will need the following items to complete the installation:

- Phillips screw driver
- Safety cable
- C-clamp or other mounting hardware
- Data cables

Complete the following procedure to install AF1000 fixtures in an indoor environment:

1. Make sure that the power is disconnected before attempting installation.
2. Using a Phillips screw driver, loosen the dome retaining clip.
3. Holding the fixture housing firmly with the dome pointing upward, remove the dome by turning it counter clockwise and lifting it off of the fixture base.
4. Holding the lamp only by its base, insert it into the lamp socket. Do not attempt to install or remove the lamp by pulling or pushing on the glass.



WARNING: If the cover (UV shield) of the HOI lamp is removed or damaged, it will not provide UV protection. Do not use the lamp!



CAUTION: Use of SOI lamp is restricted to Standard Mode. If the SOI lamp is used in Special Effect or Architectural Mode, it will dramatically shorten the life of the lamp and void the lamp's warranty.

5. Set the fixture address and personalities with the DIP switches in the base plate of the fixture. For more information on personalities, addressing and using the DIP switches, See "Modes of Operation" on page 14.
6. If you are using any accessories, such as reflectors or dichroic filters, install them now. Refer to their installation instructions in the Appendixes A and B.
7. Check to ensure the silicone O-ring is installed on the base.
8. Replace and tighten the dome such that the dome retaining clip mounted on the base aligns with the clip relief on the dome.
9. Attach the yoke to the base using the rubber washers and T-handles as shown in Figure 7.

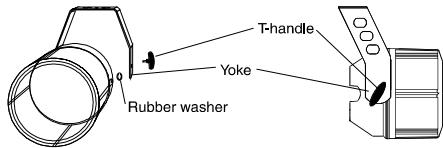

Figure 7. Yoke Attachment

10. At this point, you can mount the fixture and yoke in any of several ways: C-clamping it to a truss or bolt it to a flat surface through holes in the top of the yoke, etc. Refer to Figure 8.

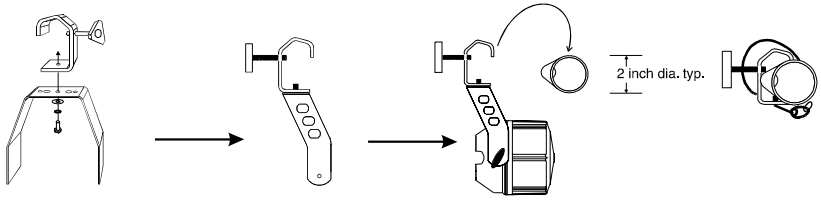

Figure 8. Mounting the Fixture

11. Insert a safety cable through the yoke and over the pipe. Place the closed loop through the eye hook.
12. Attach the data lines using the XLR connectors on the rear of the fixture.
13. Plug the power cord into a socket providing 90–255 VAC 50–60 Hz. The fixture automatically switches to match the input voltage and frequency.

Weatherized Installation Instructions

Each weatherized model is shipped with the following:

- Fixture base
- Dome
- Yoke
- 2 T-handles
- 2 rubber washers
- Silicon O-ring
- Male and female water-resistant XLR connectors

You will need the following items to complete the installation:

- Phillips screw driver
- Safety cable
- C-clamp or other mounting hardware
- Data cables

Complete the following procedure to install the weatherized AF1000:

1. Make sure that the branch circuit power is disconnected before attempting installation.
2. Using a Phillips screw driver, loosen the dome retaining clip.
3. Attach the yoke to the mounting surface, using the appropriate mounting hardware through the mounting holes located on the cross-piece of the yoke.
4. Attach the fixture to the yoke using the rubber washers and T-handles as shown in Figure 9.

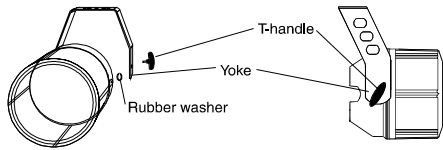

Figure 9. Yoke Attachment

5. Loosen the dome retaining clip.
6. Remove the dome by turning it counter clockwise and lifting it off of the fixture base.
7. Holding the lamp only by its base, insert it into the lamp socket. Do not attempt to install or remove the lamp by pulling or pushing on the glass.



WARNING: If the cover (UV shield) of the HOI lamp is removed or damaged, it will not provide UV protection. Do not use the lamp!



CAUTION: Use of SOI lamp is restricted to Standard Mode. If the SOI lamp is used in Special Effect or Architectural Mode, it will dramatically shorten the life of the lamp and void the lamp's warranty.

8. Set the fixture address and personalities with the DIP switches in the base plate of the fixture. For more information on personalities, addressing, and using the DIP switches see "Modes of Operation" on page 14.

9. If you are using any accessories, such as reflectors or dichroic filters, install them now. Refer to their installation instructions in the Appendixes A and B.
10. Check to ensure the silicon O-ring is installed.
11. Replace and tighten the dome such that the dome retaining clip mounted on the base aligns with the clip relief on the dome. This ensures that the dome is weather-tightened.
12. At this point, you can mount the fixture and yoke in any of several ways: C-clamping it to a truss or bolt it to a flat surface through holes in the top of the yoke, etc. Refer to Figure 10.

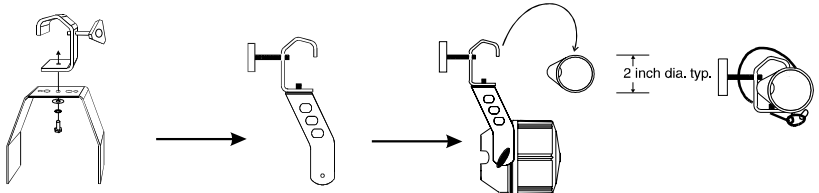

Figure 10. Mounting the Fixture

13. Insert a safety cable through the yoke and over the pipe. Place the closed loop through the eye hook.
14. Solder the female water-resistant XLR connector (supplied with the fixture) onto the incoming data line (user supplied). Solder the male water resistant XLR connector (also supplied with the fixture) on to the outgoing data line (user supplied). Refer to “Outdoor Cables” on page 9.

Modes of Operation

The AF1000 has nine operational modes:

- Self-Test Mode—demonstrates the fixture and performs a diagnostic routine
- Stand-Alone Mode—allows the fixture to operate independently without data cables or a DMX controller
- DMX Mode—seven different DMX modes allow the fixture to be controlled via a DMX controller

Self-Test Mode

To access Self-Test Mode:

1. Disconnect power from fixture and turn off all personality DIP switches.
2. Turn on the DIP switch labelled Self Test.

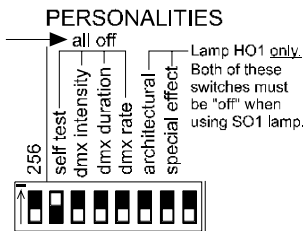

Figure 11. Self-Test Mode

3. Reconnect power to the fixture. The fixture will go through a pre-programmed test pattern one time. The pattern will run again until power is removed and reapplied or the DIP switches are changed.

Note: your AF1000 fixture is shipped in Self-Test Mode.

Stand-Alone Mode

To access Stand-Alone Mode:

1. Disconnect power from fixture and turn off all DIP switches.
2. Depending on what lamp is in the fixture, select the intensity/duty cycle you desire: standard (default—both architectural and special effect switches off), architectural, or special effect. You can program three variables: rate, intensity, and duration. Refer to Table 2.

Table 2: Stand Alone Mode







Rate	Intensity	Duration
<p>↑ slower</p> <p>Switch number 1 2 3 4 5 6 7 8 9</p> <p>Rate Intensity Duration</p>	<p>↑ dimmer</p> <p>Switch number 1 2 3 4 5 6 7 8 9</p> <p>Rate Intensity Duration</p>	<p>↑ shorter</p> <p>Switch number 1 2 3 4 5 6 7 8 9</p> <p>Rate Intensity Duration</p>
<p>↓ faster</p>	<p>↓ brighter</p>	<p>↓ longer</p>

3. Reconnect power to the fixture(s).

DMX Mode

You can control the AF1000 with DMX seven different ways. Three personality DIP switches labeled dmX intensity, dmX duration, and dmX rate control their respective functions. The following table illustrates how the various settings of these DIP switches effect the way the DMX data should be sent.

Table 3: DMX Personality Switch Settings

DMX Personalities	DMX Data Assignments		
	intensity is first DMX byte	duration is minimum	rate is set by DMX refresh ¹
	intensity is first DMX byte	duration is second DMX byte ²	rate is set by DMX refresh ¹ †
	intensity is first DMX byte	duration is second DMX byte	rate is third DMX byte ³
	intensity is first DMX byte	duration is minimum	rate is second DMX byte ³
	intensity is preset to ½	duration is minimum	rate is first DMX byte
	intensity is preset to ½	duration is first DMX byte ²	rate is set by DMX refresh ¹
	intensity is preset to ½	duration is first DMX byte	rate is second DMX byte ³
Intensity byte from DMX	Values from 0–255 are scaled by the fixture into 64 intensities.		
Duration byte from DMX	Values from 0–255 are scaled by the fixture into 64 durations. Value 0 will flash the lamp for approx. 4 milliseconds, 255 will flash it for a little more than 0.5 second.		
Rate byte from DMX	Values from 0–255 are scaled by the fixture into 64 rates. The lowest rate is a one shot move that requires a change in intensity or duration to flash again. The highest rates will appear as “latch on”—flash at 120 flashes/sec on a 60-Hz line and 100 flashes/sec on a 50 Hz line.		

¹Performance of fixtures run off of a DMX board will be heavily dependent on the intelligence and versatility of the DMX board when rate is set by the DMX refresh. Higher rates can be achieved if smaller data packets can be sent more often.

²By setting duration to a long enough period and a high rate, latch on is possible. Experiment with this.

³When using DMX to control rate, setting the slider at its lowest setting gives a “one shot” effect that only flashes the fixture once when the intensity or duration settings change. If you want to see what changes in intensity and duration look like while programming, move the rate slider up a small amount to take it out of the “one shot” mode.

†The Mini AF1000 Controller and AF1000 LCD Controller use this 2 Channel DMX Mode.

- For modes that use only one DMX channel, start channels are sequential (1, 2, 3, etc.).
- In the modes that use 2 DMX channels, sequential fixtures should be set at every other channel (1,3,5,etc.).
- In the modes that use 3 DMX channels, sequential fixtures should be set at every third channel (1,4,7,etc.).

DMX-512 Starting Channel

1. Make sure power to fixture is disconnected.
2. Plug the incoming data link into DATA IN.
3. Assign the fixture's starting channel. Use the DIP switches on the front of the base plate.

The default (all switches are off) is 1. To enter a new address:

a. Take the desired starting channel and subtract 1 from it.

address 3 - 1 = 2 address 243 - 1 = 242

b. Turn on the switches whose binary values add up to the number you got when you subtracted one from the starting channel.

channel 3 = binary 2 = switch 2 (2)

channel 243 = binary 242 = switches 8 (128) + 7 (64) + 6 (32) + 5 (16) + 2 (2)

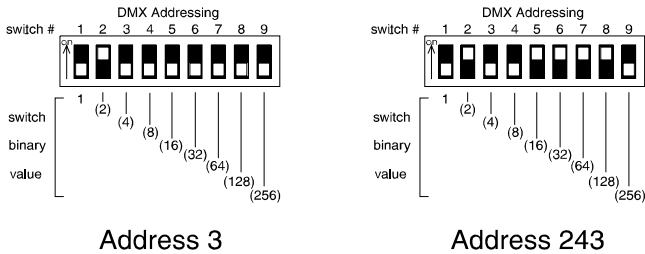

Address 3

Address 243

Figure 12. DMX Addressing

Note: see “Appendix C DIP Switch Settings for DMX-512 Starting Channel” on page 23 for complete settings.

4. To daisy-chain multiple fixtures, plug an XLR cable into the DATA OUT jack on the first unit in the chain. Plug the other end of this cable into the DATA IN plug on the next unit in the series. Repeat this step with each successive unit in the chain (connect unit 2 to 3, 3 to 4, etc.) until all units are connected. If more than 100 fixtures are used, a serial data distributor is required. See Figure 13.

Notes: do not attempt to split (parallel) the data cables to get more fixtures on a link.

Depending on the configuration, you may only be able to address 170 (three channel mode), 256 (two channel mode), or 512 (one channel mode) fixtures. AF100 fixtures do not require termination.

Daisy chain rule: You need one cable for each unit you want to connect in the daisy chain.

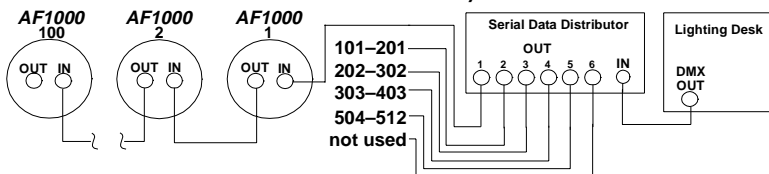

Figure 13. Daisy Chaining Fixtures

Controlling AF1000 with DMX

Intensity, rate, and duration are linearly scaled from 1 to 64 or 0 to 63. When they are controlled by DMX, use the following table to calculate values.

Table 4: AF1000 DMX Settings

DMX Value	AF1000 Value	DMX Value	AF1000 Value	DMX Value	AF1000 Value
1,2,3,4	1	61,62,63,64	16	121,122,123,124	31
5,6,7,8	2	65,66,67,68	17	125,126,127,128	32
9,10,11,12	3	69,70,71,72	18	129,130,131,132	33
13,14,15,16	4	73,74,75,76	19	133,134,135,136	34
17,18,19,20	5	77,78,79,80	20	137,138,139,140	35
21,22,23,24	6	81,82,83,84	21	141,142,143,144	36
25,26,27,28	7	85,86,87,88	22	145,146,147,148	37
29,30,31,32	8	89,90,91,92	23	149,150,151,152	38
33,34,35,36	9	93,94,95,96	24	153,154,155,156	39
37,38,39,40	10	97,98,99,100	25	157,158,159,160	40
41,42,43,44	11	101,102,103,104	26	161,162,163,164	41
45,46,47,48	12	105,106,107,108	27	165,166,167,168	42
49,50,51,52	13	109,110,111,112	28	169,170,171,172	43
53,54,55,56	14	113,114,115,116	29	173,174,175,176	44
57,58,59,60	15	117,118,119,120	30	177,178,179,180	45

Table 4: AF1000 DMX Settings

DMX Value	AF1000 Value	DMX Value	AF1000 Value	DMX Value	AF1000 Value
181,182,183,184	46	209,210,211,212	53	237,238,239,240	60
185,186,187,188	47	213,214,215,216	54	241,242,243,244	61
189,190,191,192	48	217,218,219,220	55	245,246,247,248	62
193,194,195,196	49	221,222,223,224	56	249,250,251,252	63
197,198,199,200	50	225,226,227,228	57	253,254,255,256	64
201,202,203,204	51	229,230,231,232	58		
205,206,207,208	52	233,234,235,236	59		

Intensity Mode Configuration

Intensity Modes are set by Personality DIP switches 6 and 7.



WARNING: The SOI lamp can only be used in Standard Mode. Using the SOI lamp in Architectural or Special effect mode will dramatically shorten the life of the lamp and void the warranty.

Set the DIP switches according to Table 5.

Table 5: Intensity Mode Configuration

Mode	Switches ON	Example
Standard	None	
Architectural	6	
Special Effect	7	

Troubleshooting

Use the following table to solve possible problems with AF1000.

 **CAUTION: Remove power from fixture before servicing.**

Table 6: Troubleshooting

Symptom	Possible Cause	Solution
1. Power, Status, & Data LED's not illuminated	<ul style="list-style-type: none">• Fixture not connected to power• No voltage at the plug• Fuse 1 blown	<ul style="list-style-type: none">• Connect power to fixture• Check power at plug• Contact your dealer or High End Systems Service
2. Status LED not illuminated when sending data on the DMX-512 data link	<ul style="list-style-type: none">• Data cables connected improperly• Bad data cable	<ul style="list-style-type: none">• Reconnect data cables• Check data cables with a volt-ohm meter and repair as necessary.
3. Status LED flashing at 2 Hz	<ul style="list-style-type: none">• Processor has initiated cool down	<ul style="list-style-type: none">• Wait 2-5 minutes for the fixture to complete cool down
4. Status LED flashing at 4Hz	<ul style="list-style-type: none">• Thermal switch has initiated cool down	<ul style="list-style-type: none">• Wait 2-5 minutes for the fixture to complete cool down
5. LED's illuminated, but lamp not flashing	<ul style="list-style-type: none">• Faulty lamp• Lamp not fully seated in socket• Fuse 2 blown	<ul style="list-style-type: none">• Replace lamp• Reseat lamp• Contact your dealer or High End Systems Service
6. Fixture does not respond to link	<ul style="list-style-type: none">• Incorrect personality setting• Incorrect address setting• Bad data cable	<ul style="list-style-type: none">• Check personality switch settings• Check address switch settings• Check data cables with a volt-ohm meter and repair as necessary
7. Fixture goes into cool down too quickly	<ul style="list-style-type: none">• Duration is set too high• Rate is set too high• Intensity is set too high• Special Effects Mode is being used	<ul style="list-style-type: none">• Decrease duration• Decrease rate• Decrease intensity• Switch to Architectural Mode

If any of the possibilities above are not the cause of the problem or any other problems exist, contact a qualified service technician at your dealer or distributor.

Getting Help

High End Systems Service provides a help line should you encounter problems during installation or initial operations.

U.S. and Canada

From 8 a.m. to 6 p.m. (U.S. Central time) Monday through
Friday: (800) 890-8989

24-hour FAX: (512) 834-9195

24-hour voice mail: (512) 837-3063 or (800) 890-8989

24-Hour World Wide Web Site

<http://info.highend.com/service/service.html>

24-Hour World Wide Web
Response

<http://www.highend.com>
[ftp.highend.com](ftp://ftp.highend.com)

Europe

Voice: +49 8122 9903-0
FAX: +49 8122 9903-33

Singapore

Voice: +65 742 8266
FAX: +65 743 9322

Appendix A Axial Reflector Installation

Complete the following procedure to install the optional Axial Reflector with or without dichroic filter:

1. Make sure power to the fixture is disconnected.
2. Remove the retaining clip located on the base.
3. Turn the dome counter clockwise to separate it from the fixture base.
4. Place the reflector on the base as indicated in Figure 14.

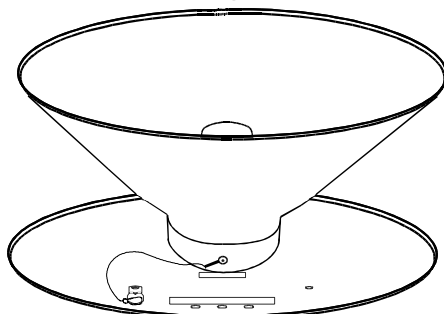

Figure 14. Axial Reflector Installation

5. Clip the safety cable from the reflector to the ring on the base.
6. Place the dome back on the fixture, rotate the dome clockwise until it reaches the stops, and secure the dome retaining clip.

Appendix B

Horizontal Reflector Installation

To install the optional horizontal reflector, complete the following procedure:

1. Make sure power to the fixture is disconnected.
2. Remove dome from fixture by first loosening the dome retaining clip located on the fixture base.
3. Turn the dome counter clockwise to separate it from the fixture base.
4. Attach the reflector to the base plate using the two self-tapping screws supplied with the reflector. Refer to Figure 15.

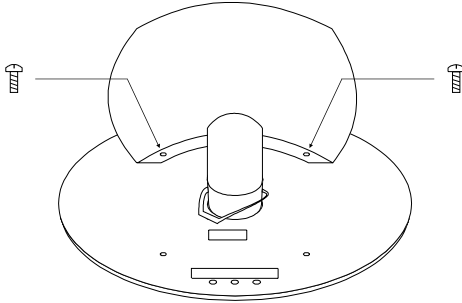

Figure 15. Horizontal Reflector Installation

5. Place the dome back on the fixture, rotate the dome clockwise until it reaches the stops, and secure the dome retaining clip.

Appendix C

DIP Switch Settings for DMX-512 Starting Channel

- For modes that use only one DMX channel, start channels are sequential (1, 2, 3, etc.).
- In the modes that use 2 DMX channels, sequential fixtures should be set at every other channel (1, 3, 5, etc.).
- In the modes that use 3 DMX channels, sequential fixtures should be set at every third channel (1, 4, 7, etc.).

Table 7: DIP Switch Settings for DMX-512 Starting Channel

Ch #	Switches ON	Ch #	Switches ON	Ch #	Switches ON	Ch #	Switches ON
1	none	13	3,4	25	4,5	37	3,6
2	1	14	1,3,4	26	1,4,5	38	1,3,6
3	2	15	2,3,4	27	2,4,5	39	2,3,6
4	1,2	16	1,2,3,4	28	1,2,4,5	40	1,2,3,6
5	3	17	5	29	3,4,5	41	4,6
6	1,3	18	1,5	30	1,3,4,5	42	1,4,6
7	2,3	19	2,5	31	2,3,4,5	43	2,4,6
8	1,2,3	20	1,2,5	32	1,2,3,4,5	44	1,2,4,6
9	4	21	3,5	33	6	45	3,4,6
10	1,4	22	1,3,5	34	1,6	46	1,3,4,6
11	2,4	23	2,3,5	35	2,6	47	2,3,4,6
12	1,2,4	24	1,2,3,5	36	1,2,6	48	1,2,3,4,6

Table 7: DIP Switch Settings for DMX-512 Starting Channel

Ch #	Switches ON	Ch #	Switches ON	Ch #	Switches ON	Ch #	Switches ON
49	5,6	66	1,7	83	2,5,7	100	1,2,6,7
50	1,5,6	67	2,7	84	1,2,5,7	101	3,6,7
51	2,5,6	68	1,2,7	85	3,5,7	102	1,3,6,7
52	1,2,5,6	69	3,7	86	1,3,5,7	103	2,3,6,7
53	3,5,6	70	1,3,7	87	2,3,5,7	104	1,2,3,6,7
54	1,3,5,6	71	2,3,7	88	1,2,3,5,7	105	4,6,7
55	2,3,5,6	72	1,2,3,7	89	4,5,7	106	1,4,6,7
56	1,2,3,5,6	73	4,7	90	1,4,5,7	107	2,4,6,7
57	4,5,6	74	1,4,7	91	2,4,5,7	108	1,2,4,6,7
58	1,4,5,6	75	2,4,7	92	1,2,4,5,7	109	3,4,6,7
59	2,4,5,6	76	1,2,4,7	93	3,4,5,7	110	1,3,4,6,7
60	1,2,4,5,6	77	3,4,7	94	1,3,4,5,7	111	2,3,4,6,7
61	3,4,5,6	78	1,3,4,7	95	2,3,4,5,7	112	1,2,3,4,6,7
62	1,3,4,5,6	79	2,3,4,7	96	1,2,3,4,5,7	113	5,6,7
63	2,3,4,5,6	80	1,2,3,4,7	97	6,7	114	1,5,6,7
64	1,2,3,4,5,6	81	5,7	98	1,6,7	115	2,5,6,7
65	7	82	1,5,7	99	2,6,7	116	1,2,5,6,7

Table 7: DIP Switch Settings for DMX-512 Starting Channel

Ch #	Switches ON	Ch #	Switches ON	Ch #	Switches ON	Ch #	Switches ON
117	3,5,6,7	134	1,3,8	151	2,3,5,8	168	1,2,3,6,8
118	1,3,5,6,7	135	2,3,8	152	1,2,3,5,8	169	4,6,8
119	2,3,5,6,7	136	1,2,3,8	153	4,5,8	170	1,4,6,8
120	1,2,3,5,6,7	137	4,8	154	1,4,5,8	171	2,4,6,8
121	4,5,6,7	138	1,4,8	155	2,4,5,8	172	1,2,4,6,8
122	1,4,5,6,7	139	2,4,8	156	1,2,4,5,8	173	3,4,6,8
123	2,4,5,6,7	140	1,2,4,8	157	3,4,5,8	174	1,3,4,6,8
124	1,2,4,5,6,7	141	3,4,8	158	1,3,4,5,8	175	2,3,4,6,8
125	3,4,5,6,7	142	1,3,4,8	159	2,3,4,5,8	176	1,2,3,4,6,8
126	1,3,4,5,6,7	143	2,3,4,8	160	1,2,3,4,5,8	177	5,6,8
127	2,3,4,5,6,7	144	1,2,3,4,8	161	6,8	178	1,5,6,8
128	1,2,3,4,5,6,7	145	5,8	162	1,6,8	179	2,5,6,8
129	8	146	1,5,8	163	2,6,8	180	1,2,5,6,8
130	1,8	147	2,5,8	164	1,2,6,8	181	3,5,6,8
131	2,8	148	1,2,5,8	165	3,6,8	182	1,3,5,6,8
132	1,2,8	149	3,5,8	166	1,3,6,8	183	2,3,5,6,8
133	3,8	150	1,3,5,8	167	2,3,6,8	184	1,2,3,5,6,8

Table 7: DIP Switch Settings for DMX-512 Starting Channel

Ch #	Switches ON	Ch #	Switches ON	Ch #	Switches ON	Ch #	Switches ON
185	4,5,6,8	202	1,4,7,8	219	2,4,5,7,8	236	1,2,4,6,7,8
186	1,4,5,6,8	203	2,4,7,8	220	1,2,4,5,7,8	237	3,4,6,7,8
187	2,4,5,6,8	204	1,2,4,7,8	221	3,4,5,7,8	238	1,3,4,6,7,8
188	1,2,4,5,6,8	205	3,4,7,8	222	1,3,4,5,7,8	239	2,3,4,6,7,8
189	3,4,5,6,8	206	1,3,4,7,8	223	2,3,4,5,7,8	240	1,2,3,4,6,7,8
190	1,3,4,5,6,8	207	2,3,4,7,8	224	1,2,3,4,5,7,8	241	5,6,7,8
191	2,3,4,5,6,8	208	1,2,3,4,7,8	225	6,7,8	242	1,5,6,7,8
192	1,2,3,4,5,6,8	209	5,7,8	226	1,6,7,8	243	2,5,6,7,8
193	7,8	210	1,5,7,8	227	2,6,7,8	244	1,2,5,6,7,8
194	1,7,8	211	2,5,7,8	228	1,2,6,7,8	245	3,5,6,7,8
195	2,7,8	212	1,2,5,7,8	229	3,6,7,8	246	1,3,5,6,7,8
196	1,2,7,8	213	3,5,7,8	230	1,3,6,7,8	247	2,3,5,6,7,8
197	3,7,8	214	1,3,5,7,8	231	2,3,6,7,8	248	1,2,3,5,6,7,8
198	1,3,7,8	215	2,3,5,7,8	232	1,2,3,6,7,8	249	4,5,6,7,8
199	2,3,7,8	216	1,2,3,5,7,8	233	4,6,7,8	250	1,4,5,6,7,8
200	1,2,3,7,8	217	4,5,7,8	234	1,4,6,7,8	251	2,4,5,6,7,8
201	4,7,8	218	1,4,5,7,8	235	2,4,6,7,8	252	1,2,4,5,6,7,8

Table 7: DIP Switch Settings for DMX-512 Starting Channel

Ch #	Switches ON	Ch #	Switches ON	Ch #	Switches ON	Ch #	Switches ON
253	3,4,5,6,7,8	255	2,3,4,5,6,7,8	DIP switch #9 adds 256 to the channel numbers to allow for starting channels above 256.			
254	1,3,4,5,6,7,8	256	1,2,3,4,5,6,7,8				

Appendix D

Important Safety Information

WARNING: FOR CONTINUED PROTECTION AGAINST FIRE

1. This equipment is designed for use with HO1 or SO1 Type lamp only. Use of any other type lamp may be hazardous and will void the warranty.
2. Do not mount on a flammable surface.
3. Maintain minimum distance of 1.0 meter (3.28 feet) from combustible materials.
4. Replace fuses only with the specified type and rating.
5. Observe minimum distance to lighted objects of 1.0 meter (3.28 feet).
6. This equipment for connection to branch circuit having a maximum overload protection of 20 A.
7. If an extension cord is necessary, a cord with a current rating at least equal to that of the appliance should be used. Cords rated for less amperage than the fixture may overheat.

WARNING: FOR CONTINUED PROTECTION AGAINST ELECTRIC SHOCK

1. Assemble line cord cap according to the instructions provided in the manual.
2. Disconnect power before re-lamping or servicing.
3. Refer servicing to qualified personnel; no user serviceable parts inside.
4. Class I equipment - this fixture employs a grounded type receptacle and is not intended for connection to a two wire, ungrounded source of supply.
5. Do not use high pressure water systems to clean weatherized architectural fixtures.
6. Do not expose indoor model of this fixture to rain or moisture.

WARNING: FOR CONTINUED PROTECTION AGAINST EXPOSURE TO EXCESSIVE ULTRAVIOLET (UV) RADIATION

1. Do not operate this equipment without complete lamp enclosure in place or if shields, lenses, or ultraviolet screens are damaged.
2. Change shields, lenses, or ultraviolet screens if they have become visibly damaged to such an extent that their effectiveness is impaired, for example by cracks or deep scratches.
3. Never look directly at the lamp while lamp is on.
4. **WARNING**—Extremely bright light. Close proximity to persons may cause eye or skin burns.

WARNING: FOR CONTINUED PROTECTION AGAINST INJURY TO PERSONS

1. Use secondary safety cable when mounting this fixture.
2. Equipment surfaces may reach temperatures up to 70 degrees C (158 degrees F). Allow 10 minutes for cooling before handling.
3. Change the lamp if it becomes damaged or thermally deformed.
4. The use of an accessory attachment not recommended by the manufacturer may cause a risk of fire, electric shock, or injury.
5. Do not remove safety cables from domes or reflectors.
6. Do not operate a fixture with a damaged cord. If the fixture has been dropped or damaged, have it examined by qualified service personnel before using.

7. Do not use unless dome is securely fastened to base.
8. CAUTION—Not for residential use.
9. There is evidence to suggest that sustained repetitive low frequency stroboscopic effects can be a factor in triggering epileptic seizures. If the AF1000 is going to be used to create this kind of effect, user may wish to advise the audience of this intent before the effect is used.

Annexe D

Informations Importantes Concernant La Sécurité

MISE EN GARDE : POUR UNE PROTECTION PERMANENTE CONTRE LES INCENDIES

1. Cet appareil est conçu pour être utilisé exclusivement avec des lampes de type HO1 ou SO1. L'usage d'autres lampes peut être dangereux et annulera la garantie.
2. Ne pas monter les lampes sur une surface inflammable.
3. Maintenir à une distance minimum de 1,0 mètre de matières inflammables.
4. Remplacer les fusibles uniquement par des fusibles du type et de la puissance spécifiés.
5. Cet appareil de connexion au circuit de dérivation comporte une protection contre les surcharges de 20 A.
6. Respecter une distance minimum de 1,0 mètre par rapport aux objets éclairés.
7. Cet appareil est conçu pour une connexion à un circuit de dérivation protégé contre les surcharges de 20 A maximum.
8. Si une rallonge s'avère nécessaire, utiliser un câble électrique d'une puissance de courant au moins égale à celle de l'appareil. En effet, les câbles dont l'intensité de courant (ampérage) est inférieure à celle de l'appareil risquent de surchauffer.

MISE EN GARDE : POUR UNE PROTECTION PERMANENTE CONTRE L'ELECTROCUTION

1. Assembler le câble électrique conformément aux instructions du manuel.
2. Débrancher l'appareil de sa source d'alimentation électrique avant de changer une lampe ou d'effectuer des réparations.
3. Confier l'entretien à un technicien qualifié ; aucune des pièces internes n'est remplaçable par l'utilisateur.
4. Equipement de Classe I - Cet appareil utilise une prise de courant reliée à la terre. Il ne doit pas être branché à un réseau à deux fils non relié à la terre.
5. Ne pas utiliser de systèmes d'eau à haute pression pour nettoyer l'appareillage électrique protégé des intempéries.
6. Ne pas exposer à pluie ou à l'humidité le modèle de cet appareil destiné à un usage intérieur.

MISE EN GARDE : POUR UNE PROTECTION PERMANENTE CONTRE DES EXPOSITIONS EXCESSIVES AUX RAYONS ULTRA- VIOLETS (UV)

1. Ne pas utiliser cet appareil si le boîtier complet de la lampe n'est pas en place ou si les blindages, lentilles, ou écrans ultraviolets sont endommagés.
2. Changer les blindages ou les écrans ultraviolets s'ils sont visiblement endommagés au point que leur efficacité soit altérée, par exemple par des fissures ou de profondes égratignures.

3. Ne jamais regarder directement la lampe quand celle ci est allumée.
4. **ATTENTION** - Lampe à forte puissance. La proximité avec des individus peut entraîner des brûlures des yeux ou de la peau.

MISE EN GARDE: POUR UNE PROTECTION PERMANENTE CONTRE LES BLESSURES CORPORELLES

1. Lors du montage de cet équipement, utiliser un câble de sécurité secondaire.
2. Les surfaces de l'appareil peuvent atteindre des températures de 70 degrés C (158 degrés F). Laisser refroidir pendant 10 minutes avant toute manipulation.
3. Changer la lampe si elle est endommagée ou thermiquement déformée.
4. L'utilisation d'accessoires non recommandés par le fabricant peut entraîner des risques d'incendie, d'électrocution, ou provoquer des blessures.
5. Ne pas retirer les câbles de sécurité des dômes ou des réflecteurs.
6. Ne pas utiliser un appareil dont le câble est abîmé. Si l'appareil est tombé ou a été endommagé, faites-le vérifier par un technicien du service après-vente avant de l'utiliser.
7. Positionner le câble de sorte que l'on ne puisse pas se prendre les pieds dedans, le tirer, ou le mettre en contact avec des surfaces brûlantes.
8. Ne pas utiliser l'appareil si le dôme n'est pas soigneusement fixé au socle.
9. **PRECAUTION** - Cet appareil n'est pas destiné à être utilisé par des particuliers.
10. Il a été prouvé que les effets stroboscopiques à basse fréquence de manière répétitive et prolongée peuvent constituer un facteur de déclenchement de crises épileptiques. Si l'utilisation du AF1000 est prévue dans le but de créer ce type d'effet, l'utilisateur souhaitera sans doute informer le public de cette intention avant d'utiliser l'effet.

Anhang D

Wichtige Hinweise für Ihre Sicherheit

WARNUNG: ZUM SCHUTZ VOR BRANDGEFAHR

1. Dieses Gerät ist nur zum Gebrauch mit einer Xenon-Blitzlampe vom Typ HO1 oder SO1 bestimmt. Die Verwendung eines anderen Lampentyps kann gefährlich sein; außerdem erlöschen alle Garantieansprüche.
2. Das Gerät nie auf einer feuergefährlichen Fläche montieren.
3. Stets einen Mindestabstand von 1 Meter zu brennbaren Materialien einhalten.
4. Sicherungen nur durch solche vom angegebenen Typ und der angegebenen Belastbarkeit austauschen.
5. Einen Mindestabstand von 1 Meter zu den angestrahlten Objekten einhalten.
6. Dieses Gerät darf nur an eine Zweigleitung mit einem Überlastungsschutz von höchstens 20 A angeschlossen werden.
7. Falls ein Verlängerungskabel erforderlich ist, sollte ein Kabel mit einer Strombelastbarkeit verwendet werden, die mindestens derjenigen des Gerätes entspricht. Verlängerungskabel mit geringerer Belastbarkeit als der Beleuchtungskörper können sich überhitzen.

WARNUNG: ZUM SCHUTZ VOR ELEKTRISCHEM SCHLAG

1. Bei der Installation des Netzkabels am Lampensockel folgen Sie bitte den Anweisungen in diesem Handbuch.
2. Vor dem Austauschen von Lampen oder vor Wartungsarbeiten stets den Netzstecker ziehen.
3. Servicearbeiten sollten nur von Fachpersonal ausgeführt werden. Das Gerät enthält keine wartungsbedürftigen Teile.
4. Dieses Gerät gehört zur Klasse I - dieser Beleuchtungskörper verwendet eine geerdete Fassung und darf nicht an eine zweipolige, ungeerdete Stromversorgung angeschlossen werden.
5. Verwenden Sie zum Reinigen von wetterfesten Beleuchtungskörpern auf keinen Fall einen Hochdruckwasserstrahl.
6. Setzen Sie ein für Innenräume bestimmtes Modell dieses Beleuchtungskörpers nie Regen oder Feuchtigkeit aus.

WARNUNG: ZUM SCHUTZ VOR ÜBERMÄSSIGER UV-STRALUNG

1. Benutzen Sie dieses Gerät nur, wenn das komplette Lampengehäuse fest eingebaut ist; außerdem dürfen keine der Schutzabdeckungen, Linsen oder der UV-Schutz beschädigungen aufweisen.
2. Die Schutzabdeckungen, Linsen und der UV-Schutz müssen ausgewechselt werden, wenn sie sichtlich dermaßen beschädigt sind, daß sie ihre Wirksamkeit einbüßen, z.B. infolge von Rissen oder tiefen Kratzern.
3. Nie direkt in die eingeschaltete Lampe schauen.
4. **WARNUNG** - Äußerst starke Lichtquelle. Personen, die sich in der Nähe des Gerätes aufhalten, können Augen- oder Hautverbrennungen erleiden.

WARNUNG: ZUM SCHUTZ VOR VERLETZUNGEN

1. Verwenden Sie bei der Installation des Beleuchtungskörpers ein zusätzliches Sicherheitskabel.
2. Die Oberflächen des Gerätes können Temperaturen bis zu 70 °C erreichen. Vor dem Anfassen stets 10 Minuten lang abkühlen lassen.
3. Falls die Lampe beschädigt oder durch Wärmeeinwirkung verformt ist, muß sie ausgewechselt werden.
4. Die Verwendung von Zusatzgeräten, die nicht den Empfehlungen des Herstellers entsprechen, kann zu Brandgefahr, elektrischem Schlag oder zu anderen Verletzungen führen.
5. Auf keinen Fall die Sicherheitskabel von den Kuppeln oder Reflektoren entfernen.
6. Keinen Beleuchtungskörper mit einem beschädigten Kabelbetreiben. Falls ein Beleuchtungskörper heruntergefallen ist oder anderweitig beschädigt wurde, sollte er vor dem Gebrauch von einem Servicespezialisten überprüft werden.
7. Nur einschalten, wenn die Kuppel fest an der Grundplatte befestigt ist.
8. **VORSICHT**-Nicht für die Benutzung in Wohnräumen bestimmt.
9. Es gibt Anzeichen dafür, daß andauernde und wiederholte niederfrequente Stroboskop-effekte epileptische Anfälle auslösen können. Wenn das AF 1000 dazu verwendet wird, einen solchen Effekt zu erzeugen, sollte der Anwender das Publikum über diese Absicht aufklären, bevor der Effekt erzeugt wird.

Apéndice D

Información Importante Sobre La Seguridad

ADVERTENCIA: PARA LA PROTECCION CONTINUA CONTRA INCENDIOS

1. Se ha diseñado este equipo para uso con lámpara tipo xenón flastube HOI o SOI solamente. El uso de otro tipo de lámpara puede resultar peligroso e invalidar la garantía.
2. No monte el equipo sobre una superficie inflamable.
3. Mantenga un metro de distancia como mínimo de los materiales combustibles.
4. Observe un metro de distancia mínima desde los objetos iluminados.
5. Este equipo debe conectarse a un circuito derivado dotado de protección máxima contra las sobrecargas de 20 A.
6. Si un cable de prolongación es necesario, debe ser un cordón de corriente nominal por lo menos igual a la del artefacto. Los cordones con un amperaje nominal inferior al del artefacto pueden sobrecalentarse.

ADVERTENCIA: PARA LA PROTECCION CONTINUA CONTRA ELECTROCUCIONES

1. Ensamble la tapa del cable de alimentación según las instrucciones del manual.
2. Desconecte el suministro de energía antes de cambiar de lámparas o de revisar el equipo.
3. Confíe la revisión al personal calificado. El interior no contiene repuestos que puedan ser reparados por el usuario.
4. Equipo de Clase I. Este aparato emplea un enchufe hembra del tipo unido a tierra, y no tiene por finalidad conectarse a una fuente de alimentación bifilar y sin puesta a tierra.
5. No emplee hidrosistemas de alta presión para limpiar instalaciones arquitectónicas curadas o preparadas a prueba de la intemperie.
6. No exponga a la lluvia o humedad el modelo de interior de este artefacto.

ADVERTENCIA: PARA PROTECCION CONTINUA CONTRA LA EXPOSICION A RADIACION ULTRAVIOLETA (UV) EXCESIVA

1. No opere este equipo sin tener colocada en su lugar la caja protectora completa de la lámpara o bien, si el blindaje, las lentes o las pantallas ultravioletas están dañadas.
2. Cambie el blindaje, las lentes o las pantallas ultravioleta si nota una avería visible, a tal grado que su eficacia se vea comprometida. Por ejemplo, en el caso de grietas o rayas profundas.
3. Jamás mire directamente a la lámpara en tanto ésta esté encendida.
4. **ADVERTENCIA:** Luz extremadamente brillante. La proximidad humana puede causar quemaduras oculares o dérmicas.

ADVERTENCIA: PARA PROTECCION CONTINUA CONTRA LESIONES CORPORALES

1. Use un cable secundario de seguridad al montar este aparato.
2. Las superficies del equipo pueden alcanzar temperaturas máximas de 70 grados centígrados. Deje que se enfrien durante 10 minutos antes de tocarlas.
3. Cambie la lámpara si ésta se avería o deforma por acción térmica.
4. El empleo de un accesorio no recomendado por el fabricante puede conllevar un riesgo de incendio, de descarga eléctrica o de lesión.

5. No quite los cables de seguridad de los domos o reflectores.
6. No opere un artefacto cuyo cable está dañado. Si el artefacto se ha caído o averiado, llévelo hágalo revisar por un personal calificado antes de usarlo.
7. No use el artefacto si el domo no se halla firmemente ajustado a la base.
8. PRECAUCION: el artefacto no es para uso residencial.
9. Existe evidencia que el uso repetitivo de bajas frecuencias estroboscópicas puede ocasionar ataques epilépticos. Si se quiere utilizar el AF 1000 para crear este efecto, rogamos avisen al público antes de proceder.

Appendice D

Informazioni Importanti Per La Sicurezza

AVVERTENZA PER LA PREVENZIONE COSTANTE DEGLI INCENDI

1. Questo apparecchio è stato progettato per l'impiego esclusivo di lampade tipo HO1 o SO1. L'impiego di altri tipi di lampade potrebbe essere pericoloso e rende nulla la garanzia.
2. Non montare su superfici infiammabili.
3. Mantenere l'apparecchio a una distanza minima di 1 m (3,28 piedi) da materiali combustibili.
4. Sostituire i fusibili solo con ricambi del tipo e della potenza nominale specificati.
5. Mantenere una distanza minima di 1 m (3,28 piedi) da oggetti accesi.
6. Questo apparecchio deve essere collegato a un circuito derivato con una protezione da sovraccarico massima di 20 A.
7. Se si rende necessario un cavo di prolunga, deve essere utilizzato un cavo con amperaggio almeno uguale a quello del dispositivo. I cavi di amperaggio minore di quello del dispositivo possono surriscaldarsi.

AVVERTENZA PER LA PREVENZIONE COSTANTE DI SCOSSE ELETTRICHE

1. Assemblare la terminazione del cavo seguendo il manuale di istruzioni.
2. Scollegare la corrente prima di sostituire la lampada o eseguire riparazioni.
3. Per qualsiasi riparazione rivolgersi a personale qualificato. L'apparecchio non contiene parti che l'utente possa riparare.
4. Apparecchio di Classe I. Questo apparecchio è fornito di spina bipolare con collegamento a terra e non deve essere collegato a rete sprovvista di terra.
5. Non usare acqua ad alta pressione per pulire dispositivi a prova di agenti atmosferici.
6. Non esporre ad agenti atmosferici i modelli da interni di questo apparecchio.

AVVERTENZA PER LA PROTEZIONE COSTANTE DA ESPOSIZIONE ECCESSIVA AI RAGGI ULTRAVIOLETTI



1. Non azionare questo apparecchio nel caso in cui la lampada non sia schermata, o gli schermi, le lenti o i filtri UV siano danneggiati.
2. Sostituire gli schermi, le lenti e i filtri UV nel caso in cui siano visibilmente danneggiati al punto da comprometterne l'efficacia, per esempio a causa di spaccature o graffi profondi.
3. Non guardare direttamente la lampada quando è accesa.
4. **AVVERTENZA.** Luce estremamente intensa che può causare bruciature agli occhi e alla pelle di chi si trova in prossimità.

AVVERTENZA PER LA PREVENZIONE COSTANTE DI INFORTUNI

1. Montare questo apparecchio usando un cavo secondario di sicurezza.
2. Le superfici dell'apparecchio possono raggiungere temperature fino a 70° C (158° F). Lasciare raffreddare l'apparecchio per 10 minuti prima di toccarlo.
3. Cambiare la lampada nel caso in cui sia danneggiata o deformata a causa delle alte temperature.
4. L'uso di accessori non raccomandati dal produttore può causare il rischio di incendi, folgorazioni o infortuni.
5. Non rimuovere i cavi di sicurezza dalle cupole o dai riflettori.
6. Non utilizzare l'apparecchio con cavi danneggiati. Nel caso in cui l'apparecchio abbia subito un urto o sia danneggiato, farlo esaminare da personale di manutenzione qualificato prima di utilizzarlo.
7. Non utilizzare l'apparecchio se la cupola non è fermamente ancorata alla base.
8. **ATTENZIONE.** Non adatto ad uso domestico.
9. Degli studi indicano che l'esposizione prolungata e ripetuta alla luce stroboscopica a bassa frequenza può provocare attacchi epilettici. Se l'AF 1000 viene usato per creare questo tipo di effetto, si consiglia che l'utilizzatore avvisi il pubblico di tale intenzione prima dell'uso.

Appendiks D Vigtig Fikker Heds Information

ADVARSEI: RESKYTTEKSE MOD ELEKTRISK SHOCK.

1. VIGTIGT! LEDERE MED GROEN/GUL ISOLATION MAA KUN TILSLUTTETES ES KLEMME MAERKET  ELLER .

Appendix E FCC Information

This equipment has been tested and found to comply with the limits for a Class A digital device, pursuant to part 15 of the FCC rules. These limits are designed to provide reasonable protection against harmful interference when the equipment is operated in a commercial environment. This equipment generates, uses, and can radiate radio frequency energy and, if not installed and used in accordance with the instruction manual, may cause harmful interference to radio communications. Operation of this equipment in a residential area is likely to cause harmful interference in which case the user will be required to correct the interference at his own expense.